



**SEI**  
INDUSTRIES

**DRAGON**<sup>®</sup>  
FIRE IGNITION PRODUCTS

***RED DRAGON***  
***OPERATIONS***  
***MANUAL***

***2021 VERSION A***

---

# **RED DRAGON OPERATIONS MANUAL**

**Version 2021A**

**PLEASE READ BEFORE USING.**

**This manual is applicable to the following models:**

DE002000 (#005851)

## **PATENTS**

AU2014200904

CA2679269

US8776693

Copies of this manual (#005853) are available from SEI.  
The manual is available on the SEI website.  
Register for manual update notifications at [dragonupdate@sei-ind.com](mailto:dragonupdate@sei-ind.com)

## **SEI INDUSTRIES LTD.**

7400 Wilson Avenue  
Delta, B.C. Canada  
V4G 1H3

Phone: (604) 946-3131

Fax: (604) 940-9566

[seisales@sei-ind.com](mailto:seisales@sei-ind.com)

[www.sei-ind.com](http://www.sei-ind.com)

---

# Revision Summary

| Version | Release Date | Revision Description  |
|---------|--------------|---|
| 2021A   | 13-Apr-2021  | <ul style="list-style-type: none"><li>• General Revision</li><li>• Appendix A updated</li></ul> |



---

# Table of Contents

|   |           |
|---|-----------|
| <b>Section 1: System Overview .....</b>         | <b>1</b>  |
| Red Dragon Dispenser .....                      | 2         |
| Components .....                                | 3         |
| Optional Components .....                       | 10        |
| <b>Section 2: Operations .....</b>              | <b>11</b> |
| Pilot and Operator Responsibilities.....        | 11        |
| Pre-Flight Procedures.....                      | 12        |
| In-Flight Procedures.....                       | 21        |
| <b>Section 3: Emergency Procedures .....</b>    | <b>23</b> |
| Equipment Malfunctions.....                     | 23        |
| Aircraft Emergency.....                         | 25        |
| Safety Considerations .....                     | 26        |
| <b>Section 4: Troubleshooting.....</b>          | <b>27</b> |
| Hopper Agitator Non-Operational .....           | 27        |
| Shuttle Drive Non-Operational .....             | 28        |
| Feed Gates Won't Open.....                      | 29        |
| Drop Rate Not Changing .....                    | 29        |
| No Emergency Water.....                         | 30        |
| Dragon Eggs Not Igniting .....                  | 30        |
| Main Circuit Breaker Trips.....                 | 30        |
| <b>Section 5: Specifications.....</b>           | <b>31</b> |
| Dispenser Specifications .....                  | 31        |
| Dragon Egg Specifications .....                 | 33        |
| <b>Section 6: Maintenance and Service .....</b> | <b>35</b> |
| Cleaning and Storage .....                      | 35        |
| Red Dragon Tool Kit .....                       | 41        |
| Spare Parts .....                               | 42        |
| <b>Section 7: Testing .....</b>                 | <b>43</b> |
| Bench Testing .....                             | 43        |
| Hangfire Test Procedure .....                   | 45        |
| <b>Section 8: Warranty.....</b>                 | <b>47</b> |
| <b>Appendix A: Dragon Tracker.....</b>          | <b>49</b> |

---

---

|   |           |
|---|-----------|
| Overview.....                             | 49        |
| Application Software.....                 | 51        |
| <b>Appendix B: Safety Data Sheet.....</b> | <b>57</b> |

---

## Section 1: System Overview

The use of controlled burning provides an effective tool in forest and wildland management. Helicopter deployed aerial ignition devices have a lengthy, proven track record of initiating these burns in an efficient, safe and controllable manner.

### Dragon Eggs

Dragon Eggs are spherical aerial ignition devices. They consist of a polystyrene plastic shell containing potassium permanganate. In this state, the spheres are stable provided the shells remain undamaged. When injected with ethylene glycol, an exothermic reaction initiates. After a delay of approximately 30 seconds, the sphere ignites. Once ignited, the plastic shell is consumed as fuel.



The Red Dragon injects a constant volume of glycol into each Dragon Egg regardless of the drop rate set by the operator. As such, the auto-ignite delay time is influenced primarily by the temperatures of the Dragon Eggs and glycol. The indicated delay times are based on air/sphere temperatures of 50 –70 degrees F (10 – 20 degrees C). Increased temperatures will decrease the delay time. By diluting the glycol with water to a 50/50 mix, the delay time can be increased.

### WARNING

The potassium permanganate within the sealed Dragon Egg is classified as a hazardous substance and, as such, must be handled and transported in the correct manner. Potassium permanganate (KMnO<sub>4</sub>) is a strong oxidizer and will react violently with certain chemicals including:

|                   |                  |                      |
|-------------------|------------------|----------------------|
| Antimony          | Aluminum Carbide | Arsenic              |
| Ethylene Glycol   | Glycerol         | Hydrogen Trisulphide |
| Hydrogen Peroxide | Phosphorus       | Sulphur              |
| Sulphuric Acid    | Titanium         |                      |

Potassium permanganate should not be inhaled or otherwise absorbed or come in contact with the skin.

## Section 1: System Overview

---

### Red Dragon Dispenser

The Red Dragon Dispenser, developed by SEI Industries Ltd., represents the next generation of aerial sphere dispensers. The primary function of the Red Dragon dispenser is to inject a measured amount of ethylene glycol into Dragon Eggs, thereby initiating an exothermic reaction, and then expel the primed spheres from the aircraft.

#### ***Operational Features***

- Seven drop rates from 25 – 175 spheres per minute.
- Tethered remote control to adjust the drop rate and control the feed gates.
- Positive displacement glycol pumps ensure constant glycol volume regardless of drop rate.
- Smart software minimizes the chance of sphere jams occurring when feed gates open.
- Re-settable sphere counter.
- Large capacity hopper holds 650 spheres.
- Removable base to fit various helicopter configurations.
- Tank drain valves.

#### ***Safety Features***

- Automatic jam detection and clearing system.
- Manual hand-wheel to clear a jam when no power is available.
- Emergency water pump with battery backup power supply.
- Low water interlock to prevent start up when the emergency water supply is low.
- Manual override to close and lock the feed gates.
- Quick release hopper to permit ejection of the hopper and the unused spheres in an emergency.

## Section 1: System Overview

---

### Components

The Red Dragon dispenser consists of a number of major components:

- **Hopper** – Stores the unprimed spheres.
- **Feed Gate Assembly** – Controls the flow of spheres into the injection head.
- **Injection Head** – Injects the spheres with glycol.
- **Outlet Chute** – Directs the spheres from the injection head to a point below the aircraft.
- **Tank Assembly** – Contains the water and glycol tanks and acts as the frame for the unit.
- **Control Panel** – Houses the control board, control switches and indicators.
- **Remote Control** – Controls the feed gates and drop rate.
- **Power Cord** – Connects dispenser to aircraft's auxiliary power system.
- **Base Mounting System** – Secures the unit to the aircraft.

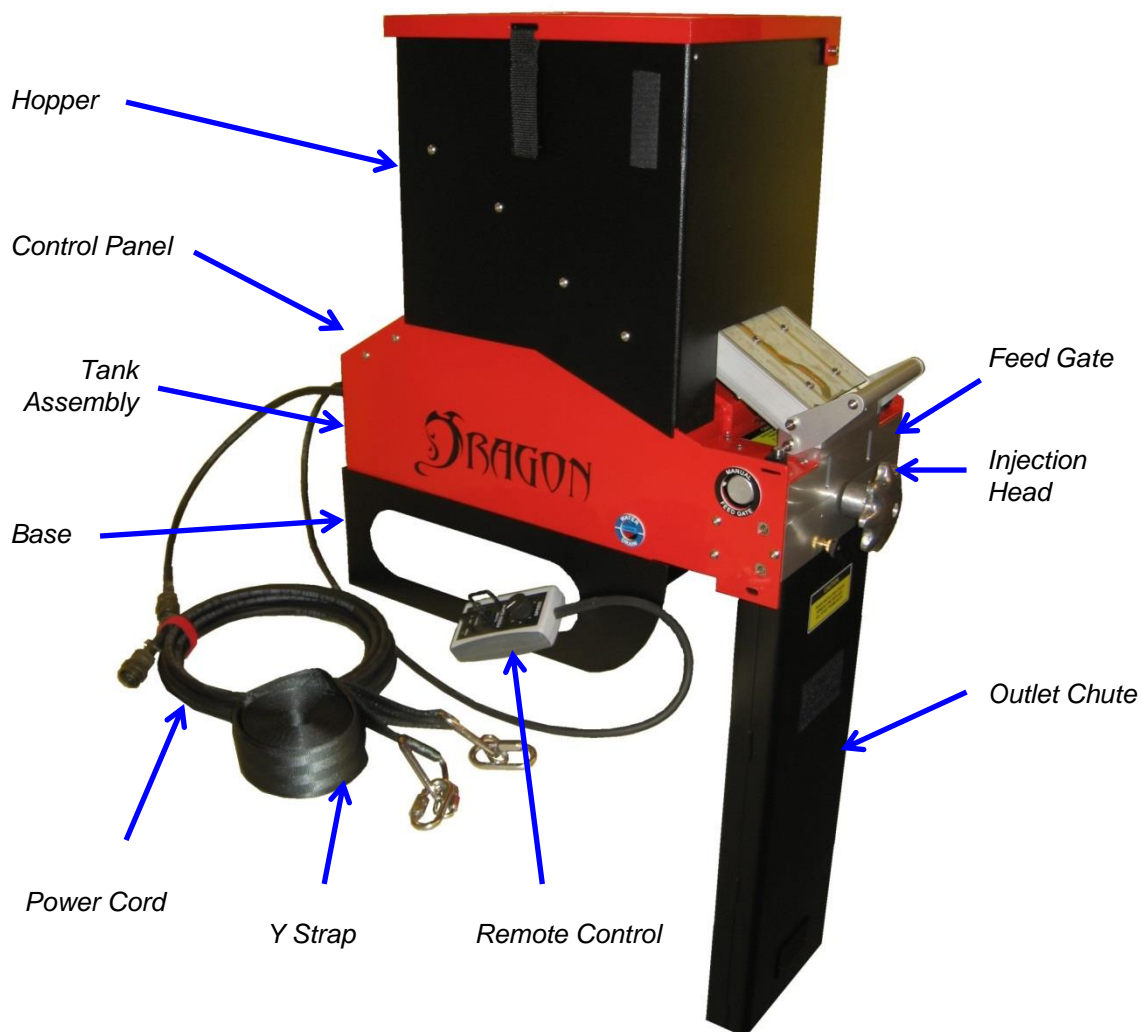



## Section 1: System Overview

---

### **Mounting System**

The standard base supplied with the Red Dragon allows the unit to be installed into a Bell series 206 helicopter. The base may be removed to allow the installation into other helicopters featuring a flat cabin floor.

The Red Dragon is secured into the helicopter using a “Y” strap that is adjustable to fit a range of cabin widths.



### **Tank Assembly**

The tank assembly houses the water and glycol tanks. It also acts as the framework to which the other components are mounted. The water and glycol systems have color-coded filler breather caps. The caps have integral strainers to prevent contamination.

Each tank is also fitted with a drain valve which can be operated using a slotted screwdriver. A short length of tubing attaches to either drain valve to direct the fluid into a suitable container.



### **Power Cords**

The standard power cord is a 15 ft. jacketed cable fitted with an MS3116F-12-3P plug to connect to the aircraft’s 28 VDC power supply (Pin A +28VDC, Pin B GND). The other end of the power cord terminates in a receptacle. A short pigtail cord from the machine’s front panel has a mating plug.



## Section 1: System Overview

---

A bench test power cord is also provided. One end of the cord is provided with a receptacle to connect to the pigtail cord on the main control panel. The other end of the cord is fitted with 1/4" ring terminals for attachment to an external power supply/battery for bench test purposes.



### *Hopper*

The hopper provides storage capacity for 650 Dragon Eggs and can be filled by the operator before or during operation. An agitator within the hopper provides a constant supply of spheres to the feed gates via two chutes.

The chutes have a clear window to allow the operator to monitor the flow of spheres from the hopper. Secondary stops, located at the outlet of the chutes, automatically close and stop the flow of spheres when the hopper is removed from the dispenser.

The hopper has a hinged lid which may be configured so that it opens towards or away from the operator. A clear polycarbonate window allows the operator to monitor the level of spheres in the hopper.



Power to the hopper is provided through a multi-pin connector that automatically mates when the hopper is placed onto the feed gate assembly. In an emergency, the hopper can be quickly removed by grasping the locking handle and lifting upwards.

### **NOTICE**

With the lid removed, the Dragon eggs are stable in the hopper under normal flight conditions. The operating authority may decide to permanently remove the lid to facilitate filling operations.

## Section 1: System Overview

---

### Feed Gate Assembly

The feed gate assembly controls the flow of spheres from the hopper into the injection head.

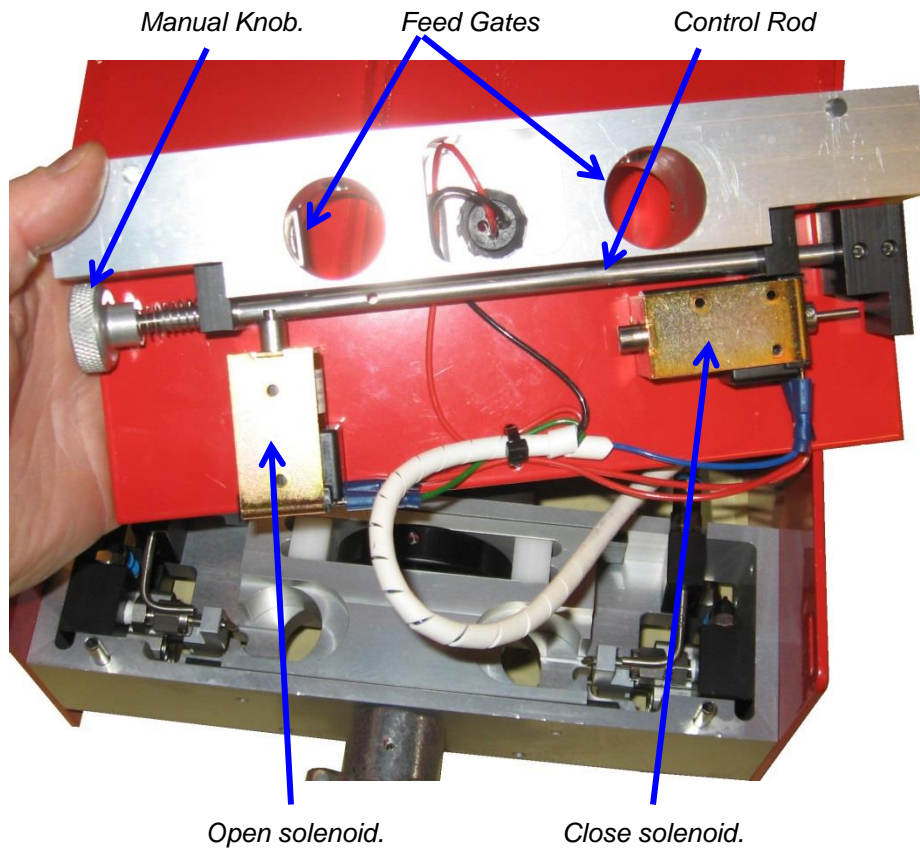

As the spheres exit the hopper, they enter two vertical passages in the feed gate assembly. Each passage has a feed gate attached to a common control rod. Pushing the rod inwards causes the feed gates to block the passages and stop the flow of spheres.

In normal operation, the position of the feed control rod and the feed gates is controlled by two solenoids, under direction, from the main controller.

To close the gates, the close solenoid energizes and pushes the rod inwards. When the rod is fully inwards, a spring-loaded pin locks into a groove in the rod to prevent it from opening. The close solenoid then de-energizes.

To open the gates, the open solenoid energizes and pulls out the locking pin. An opening spring on the feed control rod causes it to move outwards into the fully open position. The open solenoid then de-energizes.

There is a manual feed gate knob located on the end of the control rod. In an emergency, pushing on the knob will also close and lock the feed gates. The feed gates cannot be opened manually.

The feed gate assembly is located on top of the injection head by two vertical pins. It is held in place by two manual locking cams. It can be quickly disconnected from the injection head to allow access for cleaning.

## Section 1: System Overview

### Injection Head

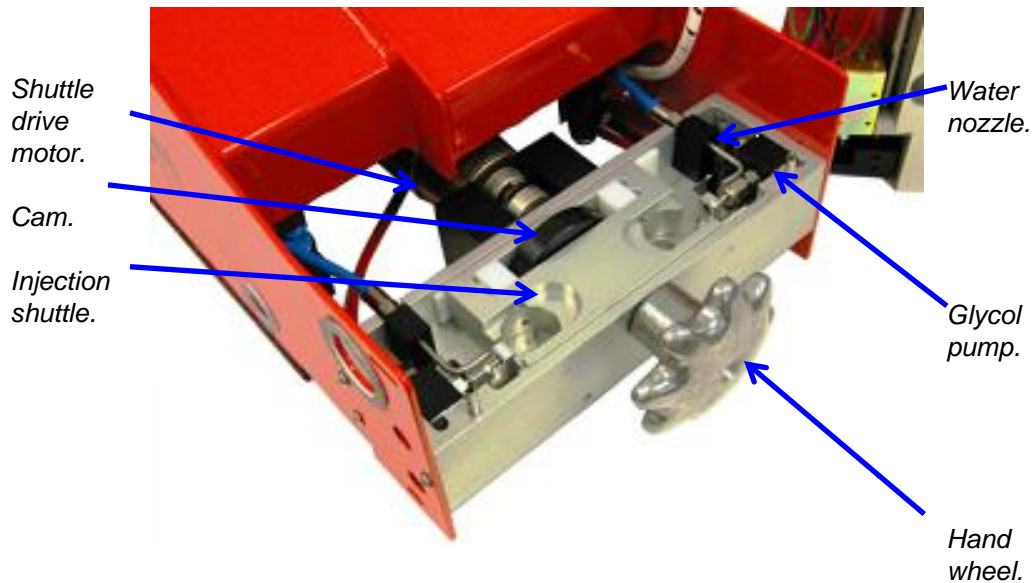

The injection head is the heart of the Red Dragon Dispenser. It is here that the Dragon Eggs are pierced by a hollow needle, injected with a controlled amount of glycol and then ejected from the machine.

The injection shuttle is located in the head. The shuttle guides the spheres as they pass through the injection head. The shuttle is driven in a reciprocating motion by a DC motor and a single offset cam. As a sphere exits the feed gate assembly, it falls into one of two cavities in the injection shuttle. Outward motion of the shuttle causes the sphere to contact the injection needle and be punctured. As the shuttle moves further outward, the sphere presses against the pump arm causing a controlled amount of glycol to be injected into the sphere.

The shuttle then reverses direction, extracting the sphere from the injection needle. It passes through the center position and continues to its full inward position. At that position, the cavity is over the exit chute, and the primed sphere drops from the shuttle and exits the machine. The two shuttle cavities are arranged such that when one side is injecting a sphere, the other side is dropping a sphere down the exit chute. This gives a steady output of spheres from the machine.

The constant displacement glycol pumps deliver the same quantity of glycol on every stroke regardless of the drop rate. This eliminates the need for the operator to calibrate the glycol system. When no sphere is present, the pump arm is not activated and no glycol flows.

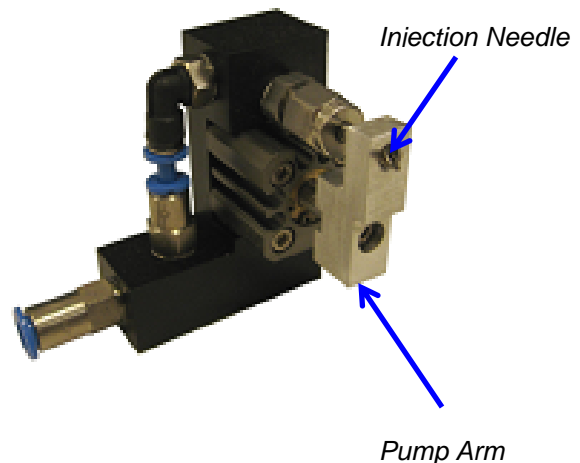

## Section 1: System Overview

If the machine is operated until the glycol pumps drain the tank, the pumps will lose their prime. The pump assemblies may be removed from the injection head and re-primed by squeezing the pump arm repeatedly until glycol flows from the injection needle. Each pump assembly is secured to the injection head by two captive screws.

The injection head also includes two water nozzles directed into the injection chambers. These nozzles are connected to a water pump and reservoir. In an emergency, the water pump can be activated by the operator to extinguish a fire in the injection chambers.

The machine is equipped with an automatic system to detect and clear sphere jams in the shuttle. However, should the automatic system fail to clear a jam, or the unit lose electrical power, a handwheel is fitted to the outboard end of the drive shaft. This handwheel can be used to turn the drive motor and cam in either direction to clear a jammed or broken sphere.

### Control Panel



The control panel is the brains of the Red Dragon system. A single circuit board mounted beneath the main control panel contains the microprocessor and all additional components.

The green “POWER” indicator on the main control panel illuminates when the machine is connected to an external power source. External power to the machine is routed through a 5A, type MS3320 manually re-settable circuit breaker which is located on the vertical front panel below the main control panel. Pulling the breaker out cuts all external power to the machine.

The “RUN/STOP” toggle switch controls the operation of the hopper and the shuttle drive motor. When the switch is set to the “RUN” position, the hopper drive motor starts and the yellow indicator above the switch illuminates. The shuttle drive motor does NOT start at this time.

## Section 1: System Overview

---

Operation of the shuttle drive motor is controlled by the feed gate switch on the tethered remote control. With the “RUN/STOP” switch in the “RUN” position and the feed gate switch toggled to the “OPEN” position, the feed gates open, and the shuttle drive motor starts. When the feed gate switch is toggled to the “CLOSE” position, the feed gates close but the shuttle drive motor continues to run for two more revolutions to purge the shuttle of any primed spheres. After the purge, the drive motor stops.

The feed gates and shuttle drive motor cannot be activated when the “RUN/STOP” switch is in the “STOP” position. However, if the switch is moved to the “STOP” position when the feed gate is open and the shuttle drive motor is already running, the feed gates will close and the motor will purge for three revolutions and then shut down.

The controller measures the actual speed of the shuttle drive motor and can determine when a jam condition has occurred in the injection shuttle. When the controller senses that a jam has occurred, the “MOTOR FAULT” indicator illuminates and the controller adjusts the shuttle drive motor direction and speed to automatically clear the jam. Once the jam is cleared, the unit returns to normal operation.

The momentary “WATER” toggle switch controls the emergency water pump. When the pump is activated, the indicator above the switch illuminates. The pump normally receives its power from the external power supply. However, if the unit loses external power, there is a battery backup that supplies power to the emergency water pump.

This battery is constantly charging when the unit is connected to an external power supply. If the unit has been stored for a long period of time and the battery has lost its charge, the warning message “bAtt” will flash on the LED segment display. The low battery condition WILL NOT prevent operation of the Red Dragon.



On older Red Dragon dispensers, with serial numbers from 101-117, there is a battery isolation switch located on the underside to prevent battery discharge over time.

There is a water level sensor located in the water tank. The “LOW WATER” indicator will illuminate when there is insufficient water in the tank for the machine to safely operate. The shuttle drive motor WILL NOT start when the “LOW WATER” indicator is illuminated.

The controller counts the number of spheres that have been processed and stores the information in two counters. The sphere count for the current operation is normally displayed on the segment LED display. The count goes to 9999 and then wraps to 0 and restarts. Pushing and holding the “RESET” toggle switch for two seconds resets the operation count to zero.



The lifetime count of spheres is displayed on the segment LED by pushing the “RESET” toggle switch momentarily. The lifetime count equals the number displayed multiplied by 1000. These counts are maintained in memory even when the unit is powered down.



The design of the control panel switches and indicators inhibits water ingress onto the circuit board. However, it does not provide a watertight enclosure and the panel is not intended to be immersed or to be sprayed with water.

## Section 1: System Overview

---

### ***Tethered Remote Control***

The tethered remote control is a hand-held device which allows the operator to control the feed gates, adjust the drop rate, and monitor the machine operation.

The green “PWR” indicator illuminates when the machine is receiving power from an external source.

The yellow “RUN” indicator illuminates when the hopper drive motor is operating. The indicator flashes when the shuttle drive motor is operating.

The red “FAULT” indicator flashes when the controller detects a jam occurring in the injection shuttle.

The “FEED GATE” switch is a three position momentary toggle that allows the operator to open or close the feed gates.

The seven-position “SPEED” control allows the operator to adjust the drop rate while the machine is in operation. The drop rates correspond to 25-175 spheres per minute in 25 spm increments.

The controller measures the shuttle drive motor speed and uses a PID algorithm to calculate how to adjust the drive motor power to ensure that the actual drop rate is equal to the selected drop rate.

The tethered remote control is attached to the front panel via a twist lock plug and a 4 ft. jacketed cable.



### **Optional Components**

#### ***Power Supply***

A 110 VAC portable power supply providing 24VDC x 10A is available for bench testing the Red Dragon.

This power supply can also be used to charge the backup battery, if required.



#### ***Dragon Tracker***

The Dragon Tracker uses a GPS receiver to track and map the dispensed spheres. See Appendix A for more details.



## Section 2: Operations

### Pilot and Operator Responsibilities

The occupants of the aircraft shall be limited to the pilot, the Red Dragon operator and the firing boss, if essential to the mission.

#### ***Pilot Duties and Responsibilities***

The pilot-in-command is responsible for all matters related to aircraft operations and safety, including installation and operation of the Red Dragon in the helicopter.

The pilot-in-command must be totally familiar with the system and its operation. The pilot shall have approval for aerial ignition operations and receive a briefing on the operational objectives as well as ground and flight procedures.

In addition to the familiarization received during the pre-flight test, the pilot must be provided with specific instructions regarding destination, objective and general procedures.

Any speed or altitude restrictions on the operation of the dispenser should be based on the flight restrictions of the particular aircraft, the desired accuracy of the ignition spheres, or any other requirements of the operating authority.

#### ***Operator Duties and Responsibilities***

The operator is responsible for the preparation, operation, maintenance and care of the Red Dragon dispenser. The machine operator must have experience with fire behaviour, be mechanically inclined and have the ability to handle several responsibilities (mental and physical) simultaneously. The operator must have successfully completed training courses in both dispenser operation and in helicopter safety.

The operator must:

- Determine if the prescribed spacing of ignition is occurring and make any necessary adjustments.
- Determine if any malfunction occurs and act accordingly.
- In the event of a fire within the Red Dragon, determine if the fire has or can be extinguished or if the unit must be jettisoned.
- Communicate with the pilot on all procedures associated with the burning operation and on any flight emergencies that may occur during the burn mission.
- Jettison the hopper, if required.



## Section 2: Operations

### Pre-Flight Procedures

#### *Bench Testing*

Bench testing shall be performed prior to each burn operation. The purpose of the bench test is to ensure satisfactory ignition of the Dragon Eggs. The Red Dragon does not require the operator to test and calibrate the quantity of glycol entering the spheres.

#### CAUTION

Ignition will occur during this test.

Do not conduct tests in or near areas where combustible sources can be ignited.

An emergency water supply or a fire extinguisher with a minimum 20 BC rating must be available in close proximity.

- Remove the base and hopper assembly and set aside.
- Remove the Red Dragon mainframe, close the crate and place the mainframe on top of the crate.
- Connect the bench test power cord to the Red Dragon dispenser.
- Connect the other end of the power cord to the optional 28VDC power supply or to two 12VDC batteries wired in series to produce 24VDC.



#### CAUTION

Ensure potassium permanganate does not come into contact with battery acid!

- Ensure glycol and water drain valves are closed (valve in horizontal position).



## Section 2: Operations

- Fill the emergency water storage tank. A safety interlock, indicated by a light on the main body control panel, will inhibit system operation if the water tank is not sufficiently filled with water.



- Fill the glycol tank with undiluted and unused ethylene glycol (anti-freeze).



- Remove the two pump assemblies from the injection head by loosening the captive screws in the side panel.



- Prime each pump assembly by squeezing and releasing the pump arm until glycol squirts from the injection needle.

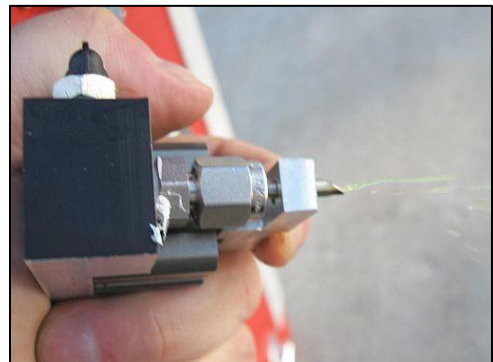

## Section 2: Operations

- Replace the pump assemblies.
- Place an open-top metal container under the injection head outlet.



- Place two spheres into each of the cavities of the gate assembly.

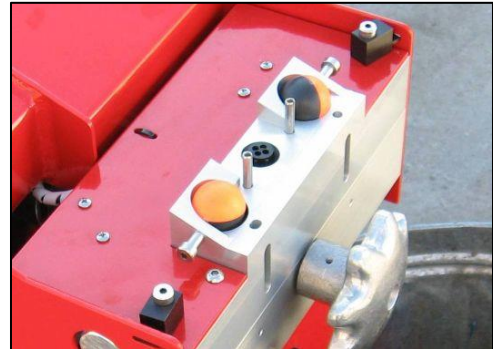

### CAUTION

Do not put water in metal tray.

- Attach the tethered remote control to the control panel on the main body.
- Press the main circuit breaker on the front panel to the reset position.
  - The “POWER” indicator on the main control panel will illuminate.



- Switch the “RUN/STOP” switch on the main control panel to “RUN”.



## Section 2: Operations

- Set the “SPEED” switch on the tethered remote control to “1.”



- Press and release the “FEED GATE” switch on the tethered remote control to the “OPEN” position.
  - The feed gates will open.
  - The shuttle drive motor will start.
  - The spheres will be injected and fall out of the injection head outlet.
- When the second sphere exits the machine, begin timing the ignition delay.
  - The injected spheres should ignite within 25-30 seconds depending on temperature. Only three of the four spheres will ignite as the first sphere is not injected.
- Press the “FEED GATE” switch on the tethered remote control to “CLOSE.”
- Switch the “RUN/STOP” switch on the main control panel to “STOP.”

### NOTICE

Increasing ambient temperatures will decrease the ignition delay time.

### Dispenser Installation

### CAUTION

The Red Dragon dispenser must be readied for installation outside the safety circle of the helicopter.

- Remove the Red Dragon system from its shipping container.



## Section 2: Operations

- Remove the hopper from the machine by grasping the hopper lock handle and pulling up.



- Ensure the glycol and water drain valves are closed.

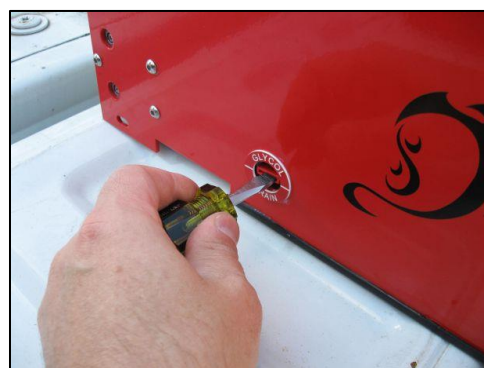

- Check/fill the water storage tank. Secure the filler/breather cap.



- Check/fill the glycol tank with undiluted and unused ethylene glycol (anti-freeze). Secure the filler/breather cap.



## Section 2: Operations

- Remove the right rear door of helicopter.
- Remove all carpet and porous floor coverings.
- Clear the cabin of all loose articles.
- Use duct tape or other means to protect the paint finish around the door. Consult with the pilot before using.
- If the support base is required, position appropriately within the aircraft. If not required, store the base in the shipping container.
- Install the Red Dragon dispenser in the door opening of the aircraft so that the injection head protrudes past the door sill.



- Attach and secure the outlet chute, using a thumbnut and locking thumbnut on each screw. The gold nut must be located on the outside of the injection head, followed by the black nut.



- Attach the Y strap by snapping the “Y” end to the holes on each side of the outboard end of the dispenser. Ensure that the strap goes inboard of the exit chute.

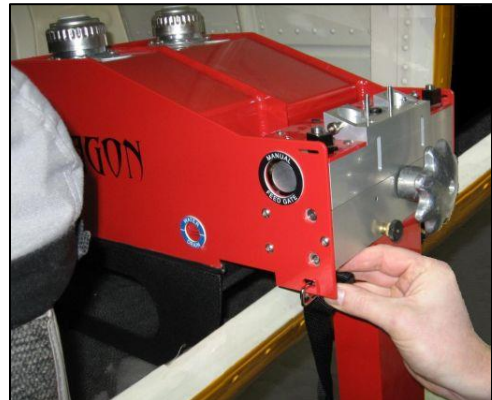

## Section 2: Operations

- Push the dispenser inboard until the main body fits snugly into the support base.



- Pass the free end of the strap beneath the belly of the aircraft and in under the opposite door. Check that the strap is not twisted or obstructing any aircraft vents, antennae or release cables. Feed the free end up and over the roller on the quick release fitting attached to the other end of the dispenser. Pull the free end to tighten the strap.



- Replace the hopper assembly onto the dispenser. Slide the dispenser as far forward as possible to provide leg-room between the dispenser and the rear seat. Ensure that the hopper lid opens freely. Tighten the belly strap snugly.
- Attach the tethered remote control cable to the control panel receptacle on the main body.
- Check that the main breaker is in the tripped (out) position.
- Connect the power cable to the auxiliary power outlet in the helicopter. Connect the other end of the power cable to the connection on the Red Dragon dispenser.
- Reset the main circuit breaker by pushing it in. The "POWER" indicator on the main control panel should illuminate. If the breaker trips immediately, this indicates that the power supply needs to have its polarity reversed.



## Section 2: Operations

---

### ***Pre-Flight Check***

The pre-flight check should be performed daily, prior to intended use. The purpose of this check is to confirm the readiness of the dispenser and support equipment.

- Press the main circuit breaker on the front panel to the reset position.
  - The “POWER” indicator on the main control panel should illuminate.
  - The “PWR” indicator on the tethered remote control should illuminate.
  - The “LOW WATER” indicator on the main control panel should not illuminate
- Switch the “RUN/STOP” switch on the main control panel to “RUN”.
  - The hopper agitator motor should start.
  - The indicator above the switch on the main control panel should illuminate.
  - The “RUN” indicator on the tethered remote control should illuminate.
- Press the “FEED GATE” switch on the tethered remote control to the “OPEN” position. Switch activates immediately and does not need to be held.
  - The feed gates should open and the shuttle drive motor should start.
  - The “RUN” indicator on the tethered remote control should flash.
  - The LED display on the main control panel should start counting spheres.
- Adjust the “SPEED” control on the tethered remote control from "1" to "7."
  - The shuttle drive motor should speed up.
- Press the “FEED GATE” switch on the tethered remote control to the “CLOSE” position. Switch activates immediately and does not need to be held.
  - The feed gates should close and the shuttle drive motor should run for a few seconds and then stop.
  - Once the shuttle drive motor has stopped, the “RUN” indicator on the tethered remote control should stop flashing and display a steady yellow light.
  - The LED display on the main control panel should stop counting spheres.
- Press the “COUNT” switch on the main control panel to the “RESET” position. HOLD the switch for a minimum of two seconds.
  - The sphere count on the LED display should reset to zero.
- Switch the “RUN/STOP” switch on the main control panel to “STOP.”
  - The indicator above the switch on the main control panel should extinguish.
  - The hopper agitator motor should stop.
- Press and hold the “WATER” switch on the main control panel to the “ON” position.
  - The water pump should start and inject water into both injection chambers.



## Section 2: Operations

---

- The indicator above the switch on the main control panel should illuminate.
- Fill the hopper with Dragon Eggs. Close and secure the lid.
- Check that any additional Dragon Eggs carried within the cabin area are properly contained and secured.
- Check the system for leaks.
- Check that additional one gallon container of water is available.
- Check that a sharp knife is within reach of the operator.
- Check intercom and ground to air communications.

### **CAUTION**

Extra ethylene glycol (antifreeze) shall not be carried in the same compartment as Dragon Eggs. Lead acid batteries shall not be carried in the cabin to power the Red Dragon.

## Section 2: Operations

### In-Flight Procedures

#### Dry Run Procedure

- Pilot should make a dry run over the burn area to ensure communications between all parties involved and to determine boundaries of the burn area.
- After the dry run over the planned area, the pilot and operator should determine the firing pattern as instructed by the burn boss or fire boss.
- The fire boss should consult the following chart to determine the drop rate for varying spacing and aircraft speeds.

### Dragon Egg Ground Spacing

|                    |   | Aircraft Ground Speed (mph) |       |       |       |        |        |        |        |        |        |        |        |        |        |
|--------------------|---|-----------------------------|-------|-------|-------|--------|--------|--------|--------|--------|--------|--------|--------|--------|--------|
|                    |   | 10                          | 15    | 20    | 25    | 30     | 35     | 40     | 45     | 50     | 55     | 60     | 65     | 70     | 75     |
| Selected Drop Rate | 1 | 35 ft                       | 53 ft | 70 ft | 88 ft | 106 ft | 123 ft | 141 ft | 158 ft | 176 ft | 194 ft | 211 ft | 229 ft | 246 ft | 264 ft |
|                    | 2 | 18 ft                       | 26 ft | 35 ft | 44 ft | 53 ft  | 62 ft  | 70 ft  | 79 ft  | 88 ft  | 97 ft  | 106 ft | 114 ft | 123 ft | 132 ft |
|                    | 3 | 12 ft                       | 18 ft | 23 ft | 29 ft | 35 ft  | 41 ft  | 47 ft  | 53 ft  | 59 ft  | 65 ft  | 70 ft  | 76 ft  | 82 ft  | 88 ft  |
|                    | 4 | 9 ft                        | 13 ft | 18 ft | 22 ft | 26 ft  | 31 ft  | 35 ft  | 40 ft  | 44 ft  | 48 ft  | 53 ft  | 57 ft  | 62 ft  | 66 ft  |
|                    | 5 | 7 ft                        | 11 ft | 14 ft | 18 ft | 21 ft  | 25 ft  | 28 ft  | 32 ft  | 35 ft  | 39 ft  | 42 ft  | 46 ft  | 49 ft  | 53 ft  |
|                    | 6 | 6 ft                        | 9 ft  | 12 ft | 15 ft | 18 ft  | 21 ft  | 23 ft  | 26 ft  | 29 ft  | 32 ft  | 35 ft  | 38 ft  | 41 ft  | 44 ft  |
|                    | 7 | 5 ft                        | 8 ft  | 10 ft | 13 ft | 15 ft  | 18 ft  | 20 ft  | 23 ft  | 25 ft  | 28 ft  | 30 ft  | 33 ft  | 35 ft  | 38 ft  |

## Section 2: Operations

---

### ***Dispensing Dragon Eggs***

- Set the "RUN/STOP" toggle on the main control panel to "RUN." The system status lights should illuminate and the hopper motor should activate.
- Set the "SPEED" switch on the tethered remote control to the desired setting.
- Enter the first flight line at operational speed and set the feed gate toggle on the tethered remote control to "OPEN." The drive motor should activate.
- Ensure a steady progression of spheres exiting the hopper.
- The feed rate can be adjusted at any time during the operation.
- As required, the feed gate toggle can be set to either "OPEN" or "CLOSE" to start or stop the flow of spheres through the machine.
- When the feed gate toggle is set to "CLOSE," the spheres already within the injection head will continue to be primed and ejected until the head is clear of all spheres at which time the drive motor will stop.
- Follow the procedures for an emergency situation as described in section 3 Emergency Procedures.

### ***Dispenser Shut-Down***

- Do not exit the burn area until all operations have ceased.
- Ensure that the feed gates are closed.
- Toggle the "RUN/STOP" switch to "STOP."
- Ensure that no spheres remain in the injection head.
- The aircraft may then leave burn area.
- Clean the unit according to daily maintenance directions in section 6 Maintenance and Service.

### ***System Fault Status***

For troubleshooting information, see section 4 Troubleshooting. Emergency repairs or system clean-out can be done by the operator at a convenient landing spot, using the troubleshooting guide, if the required tools/spare parts are available.

# Section 3: Emergency Procedures

## Equipment Malfunctions

The Red Dragon dispenser has been designed to maximize safety under normal operating conditions. By following the correct procedures, as outlined within this manual, the system will provide a consistent supply of Dragon Eggs to the target within minimal interruption. However, equipment malfunctions can still occur and, due to the nature of the operation, safety must remain paramount. Interruption of operation caused by a jammed sphere or a power failure will result in a primed sphere remaining within the injection head. Spheres remaining within the head may be primed with glycol and will auto-ignite within the head.

### *Jammed Sphere*

The operator is alerted to a jammed sphere by any of the following conditions:

- “FAULT” indicator on the tethered remote control flashes.
- “MOTOR FAULT” indicator on the main control panel illuminates.
- Manual hand-wheel stops rotation when the feed gates are open and machine has power.
- Flow of spheres into the gate block stops when the feed gates are open and machine has power.

If a sphere jam occurs in the machine, take the following immediate actions:

- If automatic clearing fails, notify the pilot of the situation.
- Press the manual feed control knob to close and lock the feed gates.
- Rotate the manual hand wheel in the reverse and forward directions to clear the jam.
- If jam clears, notify the pilot that burning can recommence.
- Toggle the feed gate switch to the “OPEN” position to reopen feed gates.

### **CAUTION**

If the hopper is removed during operations, the top two spheres in the gate assembly must be retrieved before re-attaching the hopper. Failure to do so may prevent opening of the gates.

If jam cannot be cleared and sphere ignition occurs:

- Toggle the water switch to the “ON” position and hold until the combustion has stopped.
- If necessary, pour the additional container of water into the hopper.
- Clean the ignition head as detailed in section 6 Maintenance and Cleaning.

### **WARNING**

If a fire continues or re-ignites, land immediately.

## Section 3: Emergency Procedures

---

### ***Power Failure***

Power failure to the Red Dragon machine can be caused by the following conditions:

- Tripping of the main circuit breaker.
- Accidental disconnection of the power cord.
- Tripping of the aircraft circuit breaker.
- General aircraft power system failure.

The operator is alerted to a power failure by any of the following conditions:

- All indicators on the tethered remote control and main control panel are extinguished.
- Manual hand-wheel stops rotating when the feed gates are open.
- Flow of spheres into the gate block stops when the feed gates are open.

If a power failure occurs, take the following immediate actions:

- Notify the pilot of the situation.
- Press the manual feed control knob to close and lock the feed gates.
- Rotate the manual hand-wheel three full turns to clear any remaining spheres in the ignition head.
- Investigate the cause of the power failure.

## Section 3: Emergency Procedures

---

### Aircraft Emergency

In the event of an aircraft emergency, the pilot may direct the operator to jettison all or part of the Red Dragon dispenser to remove the primary fuel and oxidizer sources from the aircraft.

#### CAUTION

Request permission from the pilot before jettisoning any equipment. Look for a suitable location to jettison, making every attempt to avoid dropping equipment over a developed area.

#### *Hopper Jettison*

To jettison the hopper, take the following immediate actions:

- Receive direction from pilot to jettison the hopper.
- Close and secure the hopper lid.
- Grasp the hopper and lift clear of the dispenser.
- Jettison the hopper through the door opening making sure to clear the aircraft structure.

#### *Machine Jettison*

If absolutely required, the remaining pieces of the Red Dragon can also be jettisoned from the aircraft.

To jettison the machine, take the following immediate actions:

- Receive direction from pilot to jettison the machine.
- Grasp the power cord on each side of the connection, twist and pull apart.
- Cut the Y strap with the cutter provided.
- Lift the main body of the machine clear of the support base and jettison through the door opening making sure to clear the aircraft structure.
- Jettison the support base through the door opening making sure to clear the aircraft structure.
- Jettison any remaining Dragon Eggs and debris.

## Section 3: Emergency Procedures

### Safety Considerations

#### Dragon Eggs

Although stable, prior to priming with ethylene glycol, the material within the sealed Dragon Egg is classified as a hazardous substance and, as such, must be handled and transported in the correct manner. Potassium permanganate (KMnO<sub>4</sub>) is a strong oxidizer and will react violently with certain chemicals as indicated in the following table.

#### WARNING

The potassium permanganate within the sealed Dragon Egg is classified as a hazardous substance and, as such, must be handled and transported in the correct manner. Potassium permanganate (KMnO<sub>4</sub>) is a strong oxidizer and will react violently with certain chemicals including:

|                   |                  |                      |
|-------------------|------------------|----------------------|
| Antimony          | Aluminum Carbide | Arsenic              |
| Ethylene Glycol   | Glycerol         | Hydrogen Trisulphide |
| Hydrogen Peroxide | Phosphorus       | Sulphur              |
| Sulphuric Acid    | Titanium         |                      |

Potassium permanganate should not be inhaled or otherwise absorbed or come in contact with the skin.

A full MSDS sheet for the chemical is included in the appendix.

## Section 4: Troubleshooting

### Section 4: Troubleshooting

This section describes remedial actions to problems that are encountered during the pre-flight bench testing and pre-flight check (see section 2 Operations, Pre-Flight Procedures). The actions are limited to those which can be performed in the field by an operator with limited tools. For more advanced troubleshooting, consult the Red Dragon Service manual.

Problems occurring during flight are covered in *section 3 Emergency Procedures, Equipment Malfunctions*.

#### Hopper Agitator Non-Operational

|                            |                                   |  |
|----------------------------|-----------------------------------|--|
| <b>No Power</b>            | "POWER" indicator not illuminated | <p>Check that the aircraft's auxiliary circuit breaker is not tripped.</p> <p>Check that the power cord is properly attached to the aircraft auxiliary outlet.</p> <p>Check that the power cord is properly attached to the pigtail cable of the dispenser.</p> <p>Check that the dispenser's main circuit breaker is not tripped.</p> |
| <b>Low Water Interlock</b> | "LOW WATER" indicator illuminated | <p>Check water level in tank. Add water as required.</p> <p>Check water drain valve is closed.</p>   |
| <b>Switch Setting</b>      | "RUN" indicator not illuminated   | <p>Check that the "RUN / STOP" switch is in "RUN" position.</p>  |
| <b>Hopper Connection</b>   | "RUN" indicator illuminated       | <p>Check that the hopper is seated correctly on gate assembly.</p>   |
| <b>Agitator Linkage</b>    | "RUN" indicator illuminated       | <p>Toggle the "RUN / STOP" switch to the "STOP" position and wait for the hand wheel to stop rotating.</p> <p>Remove the hopper from the gate assembly.</p> <p>Check that the hopper agitator mechanism is not jammed.</p> <p>Check that the hopper agitator linkages are correctly attached.</p>                                      |



## Section 4: Troubleshooting

### Shuttle Drive Non-Operational

|                            |                                     |   |
|----------------------------|-------------------------------------|---|
| <b>No Power</b>            | "POWER" indicator not illuminated   | <p>Check that the aircraft's auxiliary circuit breaker is not tripped.</p> <p>Check that the power cord is properly attached to the aircraft auxiliary outlet.</p> <p>Check that the power cord is properly attached to the pigtail cable of the dispenser.</p> <p>Check that the dispenser's main circuit breaker is not tripped.</p>  |
| <b>Low Water Interlock</b> | "LOW WATER" indicator illuminated   | <p>Check water level in tank. Add water as required.</p> <p>Check water drain valve is closed.</p>  |
| <b>Switch Setting</b>      | "RUN" indicator not illuminated     | <p>Check that the "RUN / STOP" switch is in "RUN" position.</p>   |
| <b>System Delay</b>        | "RUN" indicator steady illumination | <p>Wait for two seconds after "RUN / STOP" has been switched to the "RUN" position.</p> <p>Toggle the "FEED GATE" switch to the "OPEN" position.</p>  |
| <b>Tether Connection</b>   | "RUN" indicator steady illumination | <p>Check that the tethered remote control is properly plugged into the receptacle on the front panel.</p> <p>Toggle the "FEED GATE" switch to the "OPEN" position.</p>  |
| <b>Jammed Sphere</b>       | "MOTOR FAULT" indicator illuminated | <p>Switch the "RUN / STOP" switch to the "STOP" position.</p> <p>Pull the main circuit breaker.</p> <p>Remove the hopper.</p> <p>Unlock the gate assembly and remove.</p> <p>Examine shuttle cavities and remove jammed and/or broken spheres. Rotate manual hand wheel as required. Blow out with compressed air if available.</p> <p>Replace gate assembly and hopper.</p> <p>Reset the main circuit breaker.</p> |

## Section 4: Troubleshooting

### Feed Gates Won't Open

|                            |                                     |  |
|----------------------------|-------------------------------------|--|
| <b>No Power</b>            | "POWER" indicator not illuminated   | <p>Check that the aircraft's auxiliary circuit breaker is not tripped.</p> <p>Check that the power cord is properly attached to the aircraft auxiliary outlet.</p> <p>Check that the power cord is properly attached to the pigtail cable of the dispenser.</p> <p>Check that the dispenser's main circuit breaker is not tripped.</p>   |
| <b>Low Water Interlock</b> | "LOW WATER" indicator illuminated   | <p>Check water level in tank. Add water as required.</p> <p>Check water drain valve is closed.</p>   |
| <b>Switch Setting</b>      | "RUN" indicator not illuminated     | Check that the "RUN / STOP" switch is in "RUN" position.   |
| <b>System Delay</b>        | "RUN" indicator steady illumination | <p>Wait for two seconds after "RUN / STOP" has been switched to the "RUN" position.</p> <p>Toggle the "FEED GATE" switch to the "OPEN" position.</p>   |
| <b>Tether Connection</b>   | "RUN" indicator steady illumination | <p>Check that the tethered remote control is properly plugged into the receptacle on the front panel.</p> <p>Toggle the "FEED GATE" switch to the "OPEN" position.</p>   |
| <b>Jammed Feed Gates</b>   | "RUN" indicator flashing            | <p>Switch the "RUN / STOP" switch to the "STOP" position and wait for the hand wheel to stop rotating.</p> <p>Remove the hopper.</p> <p>Unlock the gate assembly and remove.</p> <p>Check the sphere path in the gate assembly for obstructions preventing the gates from opening.</p> <p>Switch the "RUN / STOP" switch to the "RUN" position and wait until the shuttle drive motor starts.</p> <p>Toggle the "FEED GATE" switch between the "OPEN" and "CLOSE" positions and check for movement of the feed gates</p> |

### Drop Rate Not Changing

|                          |  |   |
|--------------------------|--|---|
| <b>Remote Connection</b> |  | Check that the remote control is properly plugged into the receptacle on the front panel. |
|--------------------------|--|---|

## Section 4: Troubleshooting

### No Emergency Water

|                           |                                   |   |
|---------------------------|-----------------------------------|---|
| <b>Water Tank Empty</b>   | “LOW WATER” indicator illuminated | Check water level in tank. Add water as required.<br>Check water drain valve is closed.   |
| <b>No Power</b>           | “POWER” indicator not illuminated | Check that the aircraft’s auxiliary circuit breaker is not tripped.<br>Check that the power cord is properly attached to the aircraft auxiliary outlet.<br>Check that the power cord is properly attached to the pigtail cable of the dispenser.<br>Check that the dispenser’s main circuit breaker is not tripped. |
| <b>Battery Discharged</b> | “bAtt” indicated on LED display   | Recharge backup battery.  |

### Dragon Eggs Not Igniting

|                             |  |  |
|-----------------------------|--|--|
| <b>Glycol Tank Empty</b>    |  | Check glycol level in tank. Add glycol as required.<br>Check glycol drain valve is closed.<br>Remove pump assemblies from injection head.<br>Depress and release pump arms repeatedly until glycol flows from injection needles. |
| <b>Air in Glycol System</b> |  | Remove pump assemblies from injection head.<br>Depress and release pump arms repeatedly until glycol flows from injection needles.   |
| <b>Plugged Needle</b>       |  | Remove pump assemblies from injection head.<br>Check that injection needles are not plugged. Clean as required.  |

### Main Circuit Breaker Trips

|                         |  |   |
|-------------------------|--|---|
| <b>Reverse Polarity</b> |  | Check the polarity of the power supply. |
|-------------------------|--|---|

## Section 5: Specifications

### Dispenser Specifications

#### **Performance**

|                  |                      |
|------------------|----------------------|
| Number of speeds | 7                    |
| Min. drop rate   | 25 spheres per min.  |
| Max. drop rate   | 175 spheres per min. |
| Hopper capacity  | 650 spheres          |

#### **Power**

|                      |                                       |
|----------------------|---------------------------------------|
| Voltage              | 24-32 VDC                             |
| Connector            | MS3116F-12-3P (Pin A +28V, Pin B GND) |
| Main circuit breaker | 5A, MS3320, manual reset              |

#### **Operational Weight**

|                                   |                 |                |
|-----------------------------------|-----------------|----------------|
| Red Dragon dispenser, tanks empty | 48.0 lbs        | 21.8 kg        |
| Ethylene glycol                   | 7.9 lbs         | 3.6 kg         |
| Water supply for emergency use    | 4.1 lbs         | 1.9 kg         |
| Dragon Eggs – (650 spheres)       | <u>6.8 lbs</u>  | <u>3.1 kg</u>  |
| <b>Total operational weight</b>   | <b>66.8 lbs</b> | <b>30.4 kg</b> |

## Section 5: Specifications

---

### ***Dispenser Dimensions***

|                      |          |         |
|----------------------|----------|---------|
| Length               | 24.50 in | 62.4 cm |
| Width                | 10.75 in | 27.3 cm |
| Height               |          |         |
| With support base    | 24.00 in | 61.0 cm |
| Without support base | 19.00 in | 48.3 cm |

### ***Fluid Volumes***

|             |            |           |
|-------------|------------|-----------|
| Glycol tank | 0.8 US gal | 3.2 liter |
|-------------|------------|-----------|

(A full glycol tank will inject approximately 5,000 Dragon Egg spheres.)

#### Water tank

|                  |            |           |
|------------------|------------|-----------|
| Full             | 0.5 US gal | 1.9 liter |
| Minimum required | 0.2 US gal | 0.8 liter |

### ***Shipping Crate Dimensions***

|        |       |       |
|--------|-------|-------|
| Length | 31 in | 79 cm |
| Width  | 13 in | 33 cm |
| Height | 24 in | 61 cm |

### ***Shipping Weight***

|                                     |                      |                     |
|-------------------------------------|----------------------|---------------------|
| Red Dragon dispenser, tanks empty   | 48 lbs               | 22 kg               |
| Shipping container                  | 44 lbs               | 20 kg               |
| Miscellaneous                       | <u>2 lbs</u>         | <u>1 kg</u>         |
| <b><i>Total shipping weight</i></b> | <b><i>94 lbs</i></b> | <b><i>43 kg</i></b> |

## Section 5: Specifications

### Dragon Egg Specifications

#### Weights

|   |                |               |
|---|----------------|---------------|
| <i>Individual Dragon Egg</i>                | 0.17 oz        | 4.8 g         |
| <i>Box of 1,000 Dragon Eggs</i>             |                |               |
| Potassium permanganate (KMnO <sub>4</sub> ) | 6.6 lbs        | 3.0 kg        |
| High-impact polystyrene (HIPS) shells       | 4.0 lbs        | 1.8 kg        |
| Packaging material                          | <u>1.5 lbs</u> | <u>0.7 kg</u> |
| Gross weight                                | 12.1 lbs       | 5.5 kg        |

#### Dimensions

|                                 |         |         |
|---------------------------------|---------|---------|
| <i>Individual Dragon Egg</i>    | 1.0 in  | 26.0 mm |
| <i>Box of 1,000 Dragon Eggs</i> |         |         |
| Length                          | 16.0 in | 40.6 cm |
| Width                           | 9.0 in  | 22.9 cm |
| Height                          | 10.3 in | 26.1 cm |

#### Ignition Parameters

|   |                            |
|---|----------------------------|
| Injection to the first combustion (smoke) | 25 seconds @ 55° F (13° C) |
| Injection to full combustion (flame)      | 35 seconds @ 55° F (13° C) |
| Total useful combustion time              | 80 seconds @ 55° F (13° C) |

#### NOTICE

Increasing ambient temperatures will decrease the ignition delay time.

## Section 5: Specifications

---

### Safety

Although stable, prior to priming with ethylene glycol, the material within the sealed Dragon Egg is classified as a hazardous substance and, as such, must be handled and transported in the correct manner. Potassium permanganate (KMnO<sub>4</sub>) is a strong oxidizer and will react violently with certain chemicals as indicated below. In addition, potassium permanganate should not be inhaled or otherwise absorbed or come in contact with the skin.

#### WARNING

The potassium permanganate within the sealed Dragon Egg is classified as a hazardous substance and, as such, must be handled and transported in the correct manner. Potassium permanganate (KMnO<sub>4</sub>) is a strong oxidizer and will react violently with certain chemicals including:

|                   |                  |                      |
|-------------------|------------------|----------------------|
| Antimony          | Aluminum Carbide | Arsenic              |
| Ethylene Glycol   | Glycerol         | Hydrogen Trisulphide |
| Hydrogen Peroxide | Phosphorus       | Sulphur              |
| Sulphuric Acid    | Titanium         |                      |

Potassium permanganate should not be inhaled or otherwise absorbed or come in contact with the skin.

A full MSDS sheet for the chemical is included in the appendix.

### Dragon Egg Shipping Box Certifications

- The complete package has been tested to meet the requirements of ISTA procedure 1A.
- The complete package has been tested to meet the requirements of UN 4G combination packaging.

## Section 6: Maintenance and Service

### Cleaning and Storage

This section provides an overview of service and maintenance that can be performed in the field. The accompanying service manual provides a more extensive review.

#### **Cleaning**

This cleaning procedure shall be performed immediately following burn operations. Delay in cleaning the unit will result in the hardening of any remaining chemical in the injection head.

- Remove the Red Dragon dispenser from the aircraft.
- Wipe down the aircraft floor.
- Remove any protective tape that was installed on the aircraft door sill or fuselage.
- Remove the hopper.
  - Empty any remaining Dragon Eggs into an appropriate container.
  - Wipe down the inner surfaces of the hopper to remove any potassium permanganate dust.
  - Check the agitator and linkages for signs of excessive wear.

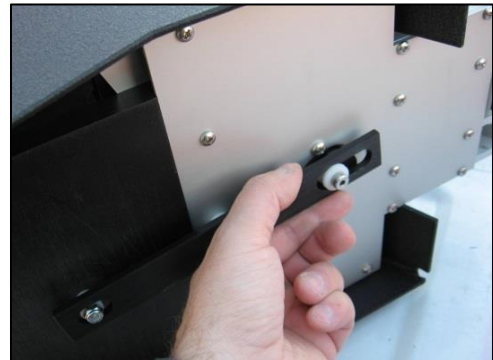

- Drain the glycol tank.
  - Insert 8 mm drain tubing into the glycol drain valve and place the other end into a suitable container.
  - Open drain valve by rotating with a slotted screwdriver so that the slot is vertical.
  - After draining, close the drain valve and remove tubing.





## Section 6: Maintenance and Service

---

- Drain the water tank.
  - Insert 8 mm drain tubing into the water drain valve and place the other end into a suitable container.
  - Open drain valve by rotating with a slotted screwdriver so that the slot is vertical.
  - After draining, close the drain valve and remove tubing.



- Remove the feed gate assembly.

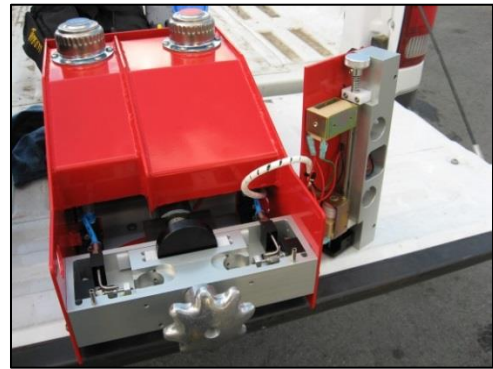

- Unlock the feed gate control rod by lifting up on the open solenoid plunger with a slotted screwdriver. The feed gate control rod should spring open.

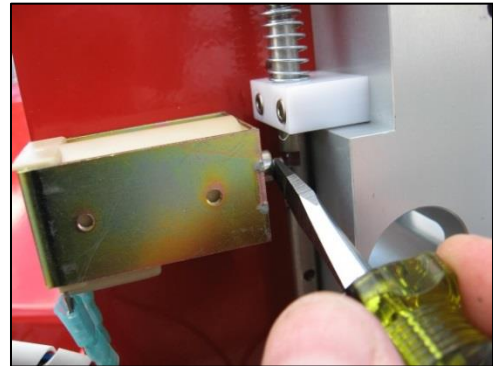

- Clean the sphere paths in the gate assembly using a cloth and a citrus-based cleaner/degreaser such as Simple Green all purpose cleaner.



## Section 6: Maintenance and Service

- Remove the glycol pump assemblies by loosening captive screws.

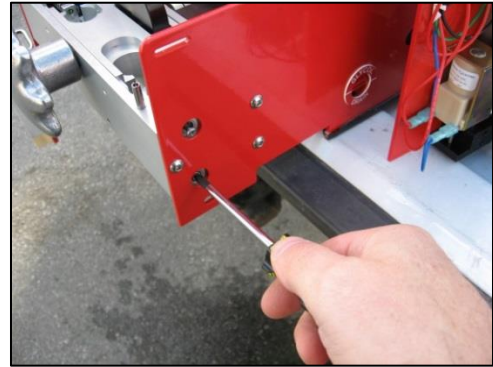

- Clean needle bore with the tool provided.
- Clean outside of needle with Scotch-Brite pad provided.
- Check the sharpness of the needle. If required, sharpen with the small file provided.
- Check pump operation by squeezing the pump arm and ensuring a squirt of glycol from the injection needle.
- Clean the injection shuttle and injection block.



### CAUTION

When mixed with water, potassium permanganate will form a dark purple liquid that will cause staining to metals and skin.

Wear latex gloves and eye protection when cleaning the unit with water.

- Loosen any potassium permanganate and polystyrene plastic residue from the shuttle and injection block using the wire brush provided. If available, used compressed air to blow out the residue.

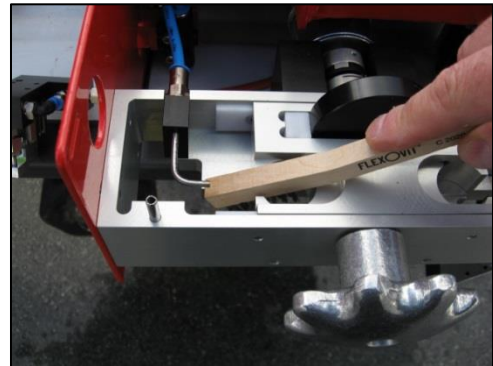

## Section 6: Maintenance and Service

- Clean the injection head and shuttle using a cloth and a citrus-based cleaner/degreaser such as Simple Green all purpose cleaner. If an appropriate cleaner is not available, water can be used (with caution).

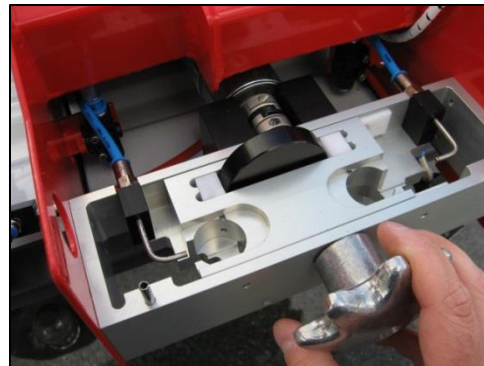

- Rotate the hand wheel to check the drive system for smooth operation.
- Check the shuttle guides for excessive wear.
- Check the cam guides in the injection shuttle for excessive wear.



### NOTICE

Do not lubricate the contact points between the injection shell, drive cam and injection block. These contact surfaces have an aluminium/polyacetal interface which is self-lubricating. The use of products such as Tri-Flo, WD-40 or light machine oil will cause dirt and permanganate residue to accumulate and may cause mechanical seizure.

- Replace the pump assemblies.
- Replace the feed gate assembly.
- Wipe down the remaining accessible surfaces on the machine.

## Section 6: Maintenance and Service

### Storage

Proper packing of the Red Dragon will ensure that no damage occurs to the unit during shipping or long term storage.

- Dry machine before re-packing in shipping crate.
- Remove the tethered remote control and place in the hopper.
- Remove the power cord and place in the hopper.
- Place mounting strap in the hopper.
- Place the bench test power cord in the hopper.
- Place the tool kit in the hopper.
- Remove the outlet chute and place in the bottom of the crate.



- Place the main body of the dispenser into the crate with the control panel facing the open end of the crate.



## Section 6: Maintenance and Service

- Replace the hopper on the dispenser.



- Place the support base in the crate between the hopper and the open end above the control panel.



- Replace the crate lid and latch the crate.
- Store the shipping crate in a dry location.

### Red Dragon Tool Kit



A field service tool kit is provided consisting of:

- slotted screwdriver for operating drain valves
- #1 Philips screwdriver for removing glycol pump assemblies
- two 7/16" open end wrenches for removing injection needles
- needle nose pliers
- 1/8" hex key wrench
- 7/64" hex key wrench
- 2.5 mm hex key wrench
- tip cleaner set for cleaning needle bore
- Scotch-Brite abrasive pad for cleaning moving parts
- small metal bristle brush

## Spare Parts

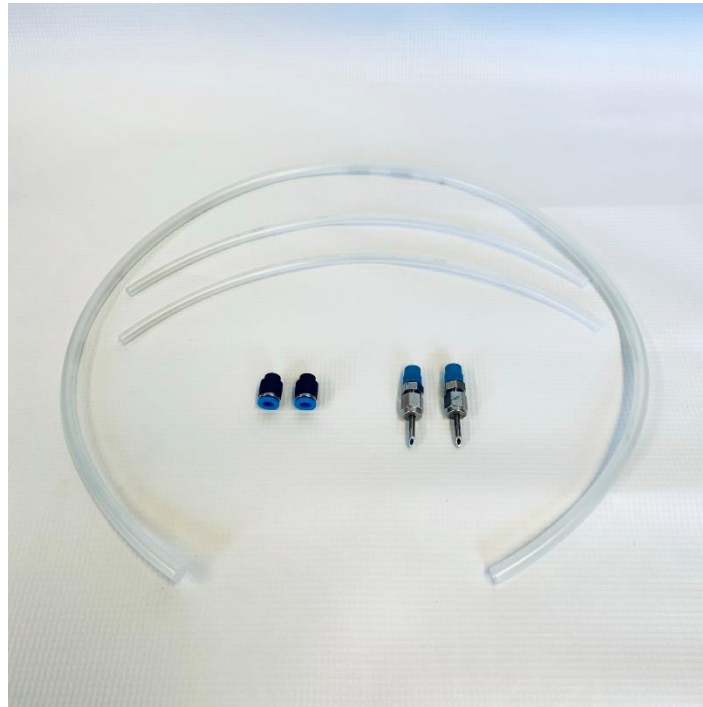

The following spare parts are included in the tool kit:

- two injection needles
- 6 mm X 25" clear tubing
- 8 mm X 32" clear tubing
- two 6 mm tube caps

## Section 7: Testing

### Bench Testing

Bench testing shall be performed prior to each burn operation. The purpose of the bench test is to ensure satisfactory ignition of the Dragon Eggs. The Red Dragon does not require the operator to test and calibrate the quantity of glycol entering the spheres.

#### CAUTION

Ignition will occur during this test.

Do not conduct tests in or near areas where combustible sources can be ignited.

An emergency water supply or a fire extinguisher with a minimum 20 BC rating must be available in close proximity.

- Remove the Red Dragon system from its shipping container.
- Remove the hopper, with lid, and set aside – this is not required for this test.
- Lift the main body clear of the support base – the support base is not required for this test.
- Mount the Red Dragon securely on a suitable table or bench.
- Connect the bench test power cord to the Red Dragon dispenser.
- Connect the other end of the power cord to the optional 28VDC power supply, or to two x 12VDC batteries wired in series to produce 24VDC.

#### CAUTION

Ensure potassium permanganate does not come into contact with battery acid.

- Ensure glycol and water drain valves are closed.
- Check/fill the emergency water storage tank. Secure filler cap. A safety interlock - indicated by a light on the main body control panel - will inhibit system operation if the water tank is not sufficiently filled with water.



## Section 7: Testing

---

- Check/fill the glycol tank with undiluted and unused ethylene glycol (anti-freeze). Secure filler cap.
- Remove the two pump assemblies from the injection head by loosening the captive screws in the side panel.
- Prime each pump assembly by squeezing and releasing the pump arm until glycol squirts from the injection needle.
- Replace the pump assemblies.
- Attach the outlet chute.
- Attach the tethered remote control to the control panel on the main body.
- Place an open-top metal container under the exit chute.

### CAUTION

Do not put water in metal tray.

- Place two spheres into each of the cavities of the gate assembly.
- Press the main circuit breaker on the front panel to the reset position.
  - The “POWER” indicator on the main control panel will illuminate.
- Switch the “RUN/STOP” switch on the main control panel to “RUN”.
- Set the “SPEED” switch on the tethered remote control to “1.”
- Press and release the “FEED GATE” switch on the tethered remote control to the “OPEN” position.
  - The feed gates will open.
  - The shuttle drive motor will start.
  - The spheres will be injected and fall out of the exit chute.
- When the second sphere exits the machine, begin timing the ignition delay.
- When the fourth sphere exits the machine, press the “FEED GATE” switch on the tethered remote control to “CLOSE”
  - The shuttle drive motor will run for three revolutions and then stop.
  - The injected spheres should ignite within 25-30 seconds depending on temperature. Only three of the four spheres will ignite as the first sphere was not injected.
- Switch the “RUN/STOP” switch on the main control panel to “STOP.”

## Section 7: Testing

---

### Hangfire Test Procedure

A hangfire test shall be performed annually at the start of the burning season. The purpose of the hangfire test is to ensure that the emergency fire suppression system is capable of extinguishing a fire in the injection head.

#### CAUTION

Ignition will occur during this test.

Do not conduct tests in or near areas where combustible sources can be ignited.

An emergency water supply or a fire extinguisher with a minimum 20 BC rating must be available in close proximity.

- Remove the hopper and set aside – it is not required for this test.
- Mount the Red Dragon securely on a suitable table or bench.
- Connect the bench test power cord to the Red Dragon dispenser.
- Connect the other end of the power cord to a 24-28 VDC external power supply.

#### CAUTION

Ensure potassium permanganate does not come into contact with battery acid.

- Ensure glycol and water drain valves are closed.
- Check/fill glycol tank.
- Check/fill emergency water tank.

#### CAUTION

Do not operate pump dry.

- Remove the glycol pump assemblies from the injection head by loosening the captive screws in the side panel.
- Prime each pump assembly by squeezing and releasing its pump arm until glycol squirts from the injection needle.
- Replace the pump assemblies.
- Attach the outlet chute.
- Place an open-top metal container under the exit chute.
- Attach the tethered remote control.

## Section 7: Testing

---

- Press the main circuit breaker on the front panel to the reset position.
  - The “POWER” indicator on the main control panel will illuminate.
- Switch the “RUN/STOP” switch on the main control panel to “RUN”.
- Press and release the “FEED GATE” switch on the tethered remote control to the “OPEN” position.
  - The feed gates will open.
  - The shuttle drive motor will start.
- Pull the main circuit breaker out to remove external power from the dispenser.
  - The shuttle drive motor will stop.
  - The feed gates will remain open.
- Switch the “RUN/STOP” switch on the main control panel to “STOP.”
- Rotate the hand wheel until the shuttle cavities align with the sphere paths in the feed gate assembly.
- Insert a Dragon Egg into each of the sphere paths in the feed gate assembly.
- Rotate the hand wheel one half turn and stop.
  - One Dragon Egg will fall out the outlet chute unprimed.
  - The second Dragon Egg will remain in the injection head and will auto-ignite after approximately 30 seconds.
- When smoke appears, press and hold the “WATER” switch on the main control panel for 10 seconds.
  - The indicator on the main control panel above the “WATER” switch will illuminate.
  - The water pump will discharge water through its nozzles into the injection chamber.
  - The fire will be extinguished.
- When the fire has been extinguished, clean the dispenser in accordance with section 6 Maintenance and Service, Cleaning and Storage.

## Section 8: Warranty

---

### Section 8: Warranty

SEI Industries Ltd. (the Company) agrees to grant a warranty for a period of two (2) years from the date of purchase of Dragon® Fire Ignition systems on the following conditions:

- a) The company's sole obligation under this warranty is limited to repairing or replacing, at the company's sole discretion, any product proved to be defective.
- b) The company's products are not guaranteed for any specific length of time or measure of service, but are warranted only to be free from defects in workmanship and material for a period of two (2) years to the original purchaser.
- c) To the extent allowable under applicable law, the company's liability for consequential and incidental damages is expressly disclaimed. The company's liability in all events is limited to, and shall not exceed, the purchase price paid.
- d) This warranty is guaranteed to the original purchaser of Dragon® Fire Ignition systems and does not extend to a subsequent purchaser or assignee.
- e) The company must receive notification in writing of any claims of warranty from the original purchaser which must give details of the claimed defect in the product.
- f) Where the original purchaser is claiming under warranty, the product must be returned to the company for inspection with all transportation and duty charges prepaid.
- g) The warranty does not extend to any product that has been accidentally damaged, abraded, altered, punctured, abused, misused or used for a purpose which has not been approved by the company.
- h) This warranty does not apply to any accessories used with the product that are not supplied by the company and any warranty on such accessories must be requested from the manufacturer or dealer of the accessories.
- i) In the event the original purchaser does not give notice of a warranty claim within two (2) years of the original purchase of the product, it is understood that the purchaser has waived the claim for warranty and the purchaser and/ or any subsequent purchaser must accept the condition of the product as it may be, without warranty.
- j) Any technical information supplied by the company regarding the product is not a condition of warranty but, rather, is information provided by the company to the best of its knowledge.
- k) There are no implied warranties nor is there any warranty that can be assumed from any representation of any person, except the company itself.

#### **Exclusions**

- l) This warranty is void if the product is not installed, used and/or maintained in accordance with the operations manual supplied by SEI.
- m) All Dragon® Fire Ignition systems are designed and manufactured with substantial safety margins. It is the responsibility of the user to ensure that the equipment is maintained to a safe standard.

**THIS PAGE INTENTIONALLY LEFT BLANK**

## Appendix A: Dragon Tracker



### Overview

The Dragon Tracker uses a GPS receiver and the dispenser motor encoder to track the position of the dispensed ignition spheres. The data is recorded on a removable MicroSD card. After the burn operation is complete, the data is processed to produce a map file in the .KML format which can be viewed on a computer. The system can be used with both the Red Dragon and Sling Dragon aerial ignition dispensers.

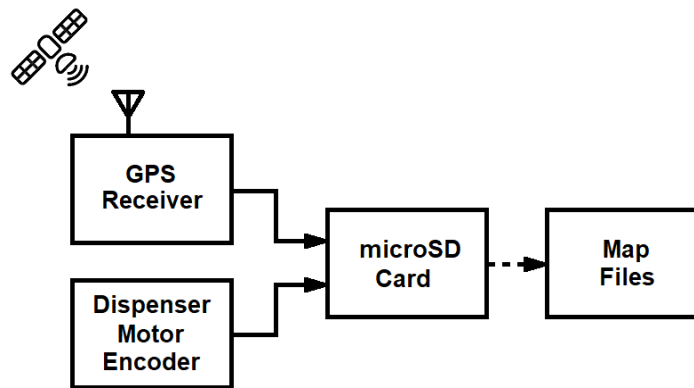

The tracker module receives its power and data via a cable which plugs into the control panel of the dispenser. A mode switch is used to select Red Dragon or Sling Dragon dispenser type. The multi-colour indicator provides information regarding the tracker status.

| Status Indicator | Details  |
|------------------|--|
| ○ Off            | Tracker has no power.                            |
| ● Flashing Red   | No MicroSD memory card installed.                |
| ● Amber          | GPS receiver has not obtained a fix.             |
| ● Green          | GPS receiver has obtained a fix and is tracking. |

## Appendix A: Dragon Tracker

The removable MicroSD memory card stores the raw tracking data. It also contains all the necessary software for processing the raw data to create the map file.

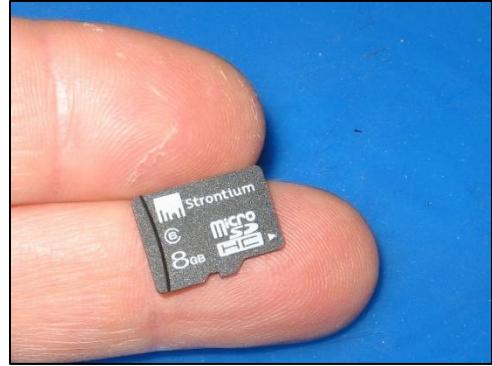

The card reader is used to transfer the data from the memory card in the tracker module to a computer for processing and display of maps. The card reader is provided, but any USB MicroSD card reader will work.



## Operation

- Attach the tracker module to the exit chute and secure in place.
- Attach the magnetic antenna to the steel plate on the lower end of the exit chute.
- Route the power / data cable from the tracker module along the side of the dispenser opposite the operator and plug the cable into the receptacle on the front panel.
- Ensure that the mode switch is in the "RED" position.
- Provide helicopter power to the dispenser.
  - The indicator will display: ●
- Wait a few minutes for the GPS receiver to get a fix on its position.
  - Once the GPS receiver has a fix, the indicator will display: ●
- The Dragon Tracker is ready for use and will automatically track the spheres.
- After use, remove the tracker module and antenna and place them in the dispenser tool bag before storing the Red Dragon in its crate.

### Troubleshooting

| Indicator | Problem             | Remedial Action   |
|-----------|---------------------|---|
| ○         | Tracker not powered | Ensure the power / data cable is connected to dispenser.  |
| ☀         | No MicroSD Card     | Disconnect the power / data cable.<br>Install the micro SD card into the tracker module.<br>Reconnect the power /data cable.              |
| ●         | No GPS Fix          | Ensure the external antenna is connected.<br>Ensure the antenna is not hidden from satellites.<br>Wait for the GPS receiver to get a fix. |

### Application Software

The Dragon Tracker stores location data on the micro SD memory card in a raw format. In order to use this data, it must first be processed. This processing is done by additional software contained on the memory card.

- Open the latch on the tracker module.
- Open the tracker module.
- Press and release on the end of the memory card.
- Remove the memory card from the tracker module.





## Appendix A: Dragon Tracker

- Insert the memory card into the card reader.



- Install the card reader into a USB slot on a Windows based computer.
  - A new window will open.
  - Your drive name may differ.

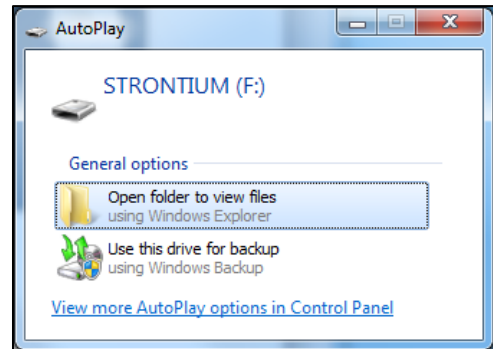

- Click on "Open folder to view files".
  - A new window will open.

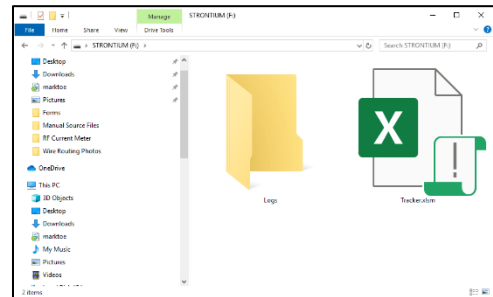

- Double Click the "Dragon Tracker" application icon.
  - A new excel application window will open.

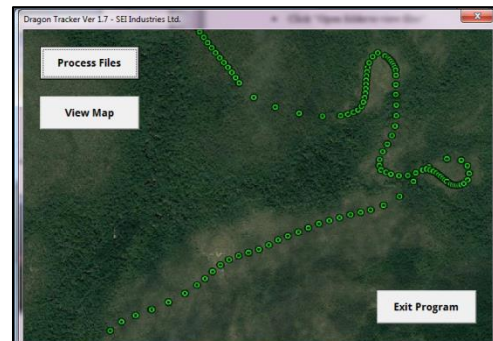

## Appendix A: Dragon Tracker

---

The first step is to process the raw data file to create a map file. Each data file only needs to be processed once.

- Click the “Process Files” button.
  - A new window will open.

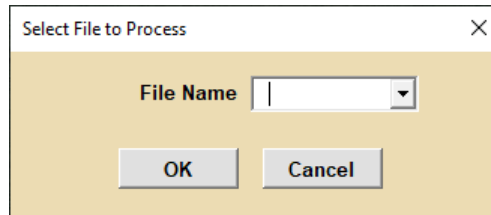

- Click the down arrow on the “File Name” list.
  - A list of files requiring processing will appear.
  - The files are named with the date format YYYYMMDD.
- From the list, select a file to process.
- Click the “OK” button.
  - A new window will open.

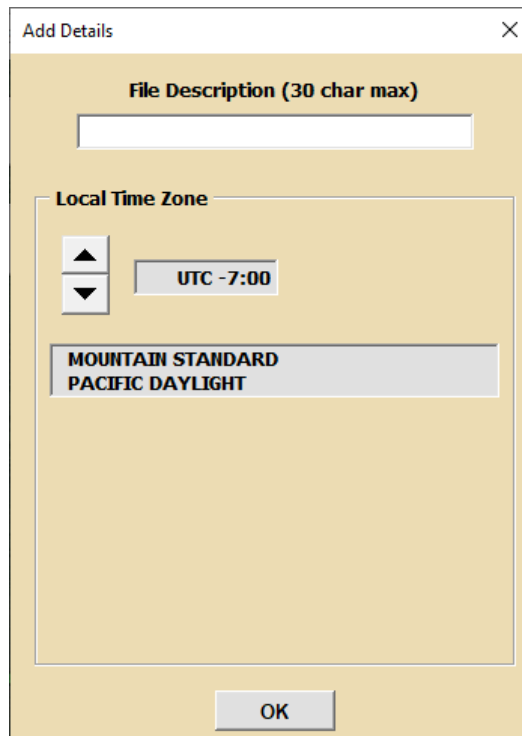

## Appendix A: Dragon Tracker

---

- Enter a description to help identify the file (ie Alligator Creek).
- Use the up and down arrows to adjust the Local Time Zone until your time zone appears in the list.
- Click the “OK” button.
  - The raw data will now be processed into a map file with a .KML file extension.
  - The map file will be stored on the memory card in the Logs folder.
  - A duplicate file will be stored on the hard drive of the computer in the following folder:

*C:\ProgramData\DragonTracker*

### View Map

Once processed into a map file, the data can be viewed using any program capable of displaying files with a .KML file extension. There are many free viewers available, with Google Earth being the most common.

- Click the “View Map” button.

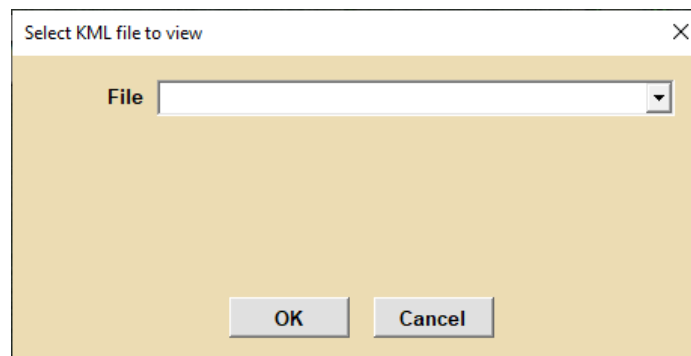

- A new window will open.
- Click the down arrow on the “File Name” box.
  - A list of map files will appear.
- Select the desired file.
- Click the “OK” button.
  - The default .KML file viewer will open and display the selected file.
  - If no .KML file viewer is installed, a caution notice will be displayed.

The positions of the spheres will be shown in the map viewer as a series of green dots. Each dot represents one sphere. Red dots indicate approximate sphere positions when the system lost satellite contact and interpolated where the sphere was dropped based on the previous and next sphere positions.

Some map viewers have a sliding time bar or animation that will show the time and progression of the spheres.

## Appendix A: Dragon Tracker

---

### *Exit Program*

To exit the program:

- Click the “Exit Program” button.



## Appendix B: Safety Data Sheet

# Appendix B: Safety Data Sheet

### 1. Identification

|   |   |
|---|---|
| Product identifier  | CAIROX® potassium permanganate  |
| Other means of identification                                 |   |
| SDS Number  | -   |
| Recommended use   | Potassium Permanganate is an oxidant recommended for applications that require a strong oxidant.  |
| Recommended restrictions                                      | Use in accordance with supplier's recommendations.  |
| <b>Manufacturer/Importer/Supplier/Distributor information</b> |   |
| Company Name  | CARUS CORPORATION   |
| Address   | 315 Fifth Street,<br>Peru, IL 61354, USA  |
| Telephone   | 815 223-1500 - All other non-emergency inquiries about the product should be directed to the company  |
| E-mail  | salesmkt@caruscorporation.com   |
| Website   | www.caruscorporation.com  |
| Contact Person  | Dr. Chithambarathanu Pillai   |
| Emergency Telephone   | For Hazardous Materials [or Dangerous Goods] Incidents ONLY (spill, leak, fire, exposure or accident), call CHEMTREC at CHEMTREC®, USA: 001 (800) 424-9300<br>CHEMTREC®, Mexico (Toll-Free - must be dialed from within country): 01-800-681-9531<br>CHEMTREC®, Other countries: 001 (703) 527-3887 |



### 2. Hazard(s) Identification

|                       |  |   |
|-----------------------|--|---|
| Physical Hazards      | Oxidizing solids                                       | Category 2  |
| Health Hazards        | Acute toxicity, oral                                   | Category 4  |
|                       | Skin corrosion/irritation                              | Category 1B   |
|                       | Serious eye damage/eye irritation                      | Category 1  |
|                       | Specific target organ toxicity, single exposure        | Category 1 (Respiratory System)                         |
|                       | Specific target organ toxicity, repeated exposure      | Category 1 (Respiratory System, Central Nervous System) |
| Environmental Hazards | Hazardous to the aquatic environment, acute hazard     | Category 1  |
|                       | Hazardous to the aquatic environment, long-term hazard | Category 1  |
| OSHA Defined Hazards  | Not classified.  |   |

#### Label Elements



|                         |  |
|-------------------------|--|
| Signal Word             | Danger   |
| Hazard Statement        | May intensify fire; oxidizer. Harmful if swallowed. Causes severe skin burns and eye damage. Causes damage to organs (Respiratory System). Causes damage to organs (Respiratory System, Central Nervous System) through prolonged or repeated exposure. Very toxic to aquatic life with long lasting effects.  |
| Precautionary Statement |  |
| Prevention              | Keep away from heat. Keep/Store away from clothing and other combustible materials. Take any precaution to avoid mixing with combustibles. Do not breathe dust. Wash thoroughly after handling. Wear protective gloves/protective clothing/eye protection/face protection. Do not eat, drink or smoke when using this product. Avoid release to the environment. |

## Appendix B: Safety Data Sheet

|  |  |
|--|--|
| <b>Response</b>                                  | In case of fire: Use water for extinction. If swallowed: Rinse mouth. Do NOT induce vomiting. If on skin (or hair): Take off immediately all contaminated clothing. Rinse skin with water/shower. Wash contaminated clothing before reuse. If in eyes: Rinse cautiously with water for several minutes. Remove contact lenses, if present and easy to do. Continue rinsing. If inhaled: Remove person to fresh air and keep comfortable for breathing. Immediately call a poison center/doctor. If exposed: Call a poison center/doctor. Collect spillage. |
| <b>Storage</b>                                   | Store locked up  |
| <b>Disposal</b>                                  | Dispose of contents/container in accordance with local/regional/national/international regulations.  |
| <b>Hazard(s) not otherwise classified (HNOC)</b> | None known.  |

### 3. Composition / Information on Ingredients

| Substances             |                          |            |       |
|------------------------|--------------------------|------------|-------|
| Chemical Name          | Common Name and Synonyms | CAS Number | %     |
| Potassium Permanganate |                          | 7722-64-7  | >97.5 |

**Composition Comments** All concentrations are in percent by weight unless ingredient is a gas. Gas concentrations are in percent by volume.

### 4. First-Aid Measures

|   |  |
|---|--|
| <b>Inhalation</b>   | Remove victim to fresh air and keep at rest in a position comfortable for breathing. For breathing difficulties, oxygen may be necessary. Get medical attention immediately.   |
| <b>Skin Contact</b>   | Take off immediately all contaminated clothing. Immediately flush skin with plenty of water. Get medical attention immediately. Wash contaminated clothing before reuse.<br><br>Contact with skin may leave a brown stain of insoluble manganese dioxide. This can be easily removed by washing with a mixture of equal volume of household vinegar and 3% hydrogen peroxide, followed by washing with soap and water. |
| <b>Eye Contact</b>  | Immediately flush with plenty of water for up to 15 minutes. Remove any contact lenses and open eyelids wide apart. Continue rinsing. Get medical attention immediately.   |
| <b>Ingestion</b>  | Immediately rinse mouth and drink plenty of water. Never give anything by mouth to a victim who is unconscious or is having convulsions. Do not induce vomiting. If vomiting occurs, keep head low so that stomach content doesn't get into the lungs. Get medical attention immediately.  |
| <b>Most important symptoms/effects, acute and delayed</b>                     | Contact with this material will cause burns to the skin, eyes and mucous membranes. Permanent eye damage including blindness could result.   |
| <b>Indication of immediate medical attention and special treatment needed</b> | Provide general supportive measures and treat symptomatically. In case of shortness of breath, give oxygen. Decomposition products are alkaline. Brown stain is insoluble manganese dioxide  |
| <b>General information</b>  | In the case of accident or if you feel unwell, seek medical advice immediately (show the label where possible). Ensure that medical personnel are aware of the material(s) involved, and take precautions to protect themselves. Show this safety data sheet to the doctor in attendance. For personal protection, see Section 8 of the SDS. Wash contaminated clothing before reuse.                                  |

## Appendix B: Safety Data Sheet

---

### 5. Fire-fighting measures

|  |  |
|--|--|
| <b>Suitable extinguishing media</b>                                  | Flood with water from a distance, water spray or fog.  |
| <b>Unsuitable extinguishing media</b>                                | The following extinguishing media are ineffective: Dry chemical. Foam. Carbon dioxide (CO <sub>2</sub> ). Halogenated materials.   |
| <b>Specific hazards arising from the chemical</b>                    | May intensify fire; oxidizer. May ignite combustibles (wood, paper, oil, clothing, etc.). Contact with incompatible materials or heat (135 °C / 275 °F) could result in violent exothermic chemical reaction. Oxidizing agent, may cause spontaneous ignition of combustible materials. By heating and fire, corrosive vapors/gases may be formed. |
| <b>Special protective equipment and precautions for firefighters</b> | Self-contained breathing apparatus and full protective clothing must be worn in case of fire. Selection of respiratory protection for firefighting: follow the general fire precautions indicated in the workplace.  |
| <b>Fire-fighting equipment/instructions</b>                          | Move container from fire area if it can be done without risk. Cool containers exposed to flames with water until well after the fire is out. Prevent runoff from fire control or dilution from entering streams, sewers, or drinking water supply. Dike fire control water for later disposal. Water runoff can cause environmental damage.        |
| <b>General fire hazards</b>  | The product is not flammable. May intensify fire; oxidizer. May ignite combustibles (wood, paper, oil, clothing, etc.). Contact with incompatible materials or heat (135 °C / 275 °F) could result in violent exothermic chemical reaction.  |

### 6. Accidental release measures

|  |   |
|--|---|
| <b>Personal precautions, protective equipment and emergency procedures</b> | Keep unnecessary personnel away. Keep upwind. Do not touch damaged containers or spilled material unless wearing appropriate protective clothing. Avoid inhalation of vapors and contact with skin and eyes. Wear protective clothing as described in Section 8 of this safety data sheet. Local authorities should be advised if significant spillages cannot be contained   |
| <b>Methods and materials for containment and cleaning up</b>               | Keep combustibles (wood, paper, oil, etc.) away from spilled material. Should not be released into the environment. This product is miscible in water. Stop leak if possible without any risk. Dike the spilled material, where this is possible. Clean up spills immediately by sweeping or shoveling up the material. Do not return spilled material to the original container; transfer to a clean metal or plastic drum. To clean up potassium permanganate solutions, follow either of the following two options:<br><br>Option # 1: Dilute to approximately 6% with water, and then reduce with sodium thiosulfate, a bisulfite or ferrous salt solution. The bisulfite or ferrous salt may require some dilute sulfuric acid (10% w/w) to promote reduction. Neutralize with sodium carbonate to neutral pH, if acid was used. Decant or filter and deposit sludge in approved landfill. Where permitted, the sludge may be drained into sewer with large quantities of water.<br><br>Option # 2: Absorb with inert media like diatomaceous earth or inert floor dry, collect into a drum and dispose of properly. Do not use saw dust or other incompatible media. Disposal of all materials shall be in full and strict compliance with all federal, state, and local regulations pertaining to permanganates.<br><br>To clean contaminated floors, flush with abundant quantities of water into sewer, if permitted by federal, state, and local regulations. If not, collect water and treat as described above.<br><br>Never return spills in original containers for re-use. For waste disposal, see Section 13 of the SDS |
| <b>Environmental precautions</b>   | Do not allow to enter drains, sewers or watercourses. Contact local authorities in case of spillage to drain/aquatic environment.   |

### 7. Handling and storage

|   |   |
|---|---|
| <b>Precautions for safe handling</b>                                | Take any precaution to avoid mixing with combustibles. Do not get this material in your eyes, on your skin, or on your clothing. Do not breathe dust or mist or vapor of the solution. Use personal protection as recommended in Section 8 of the SDS. If clothing becomes contaminated, remove and wash off immediately. When using, do not eat, drink or smoke. Good personal hygiene is necessary. Wash hands and contaminated areas with water and soap before leaving the work site. Avoid release to the environment. |
| <b>Conditions for safe storage, including any incompatibilities</b> | Store locked up. Keep container tightly closed and in a well-ventilated place. Store in a cool, dry place. Store away from incompatible materials (See Section 10). Store in accordance with NFPA 430 requirements for Class II oxidizers.  |



## Appendix B: Safety Data Sheet

### 8. Exposure controls/personal protection

#### Occupational exposure limits

##### US. OSHA Table Z-1 Limits for Air Contaminants (29 CFR 1910.1000)

| Components                                | Type    | Value               |
|---|---------|---------------------|
| Potassium permanganate<br>(CAS 7722-64-7) | Ceiling | 5 mg/m <sup>3</sup> |

##### US. ACGIH Threshold Limit Values

| Material                       | Type | Value                  | Form                |
|--------------------------------|------|------------------------|---------------------|
| CAIROX® potassium permanganate | TWA  | 0.1 mg/m <sup>3</sup>  | Inhalable fraction  |
|                                |      | 0.02 mg/m <sup>3</sup> | Respirable fraction |

| Components                                | Type | Value                  | Form                |
|---|------|------------------------|---------------------|
| Potassium permanganate<br>(CAS 7722-64-7) | TWA  | 0.1 mg/m <sup>3</sup>  | Inhalable fraction  |
|   |      | 0.02 mg/m <sup>3</sup> | Respirable fraction |

##### US. NIOSH: Pocket Guide to Chemical Hazards

| Material                       | Type | Value               | Form  |
|--------------------------------|------|---------------------|-------|
| CAIROX® potassium permanganate | TWA  | 1 mg/m <sup>3</sup> | Fume. |

| Components                                | Type | Value               | Form  |
|---|------|---------------------|-------|
| Potassium permanganate<br>(CAS 7722-64-7) | STEL | 3 mg/m <sup>3</sup> | Fume. |
|   | TWA  | 1 mg/m <sup>3</sup> | Fume. |

#### Biological limit values

No biological exposure limits noted for the ingredient(s).

#### Exposure guidelines

Follow standard monitoring procedures.

#### Appropriate engineering controls

Provide adequate general and local exhaust ventilation. An eye wash and safety shower must be available in the immediate work area.

#### Individual protection measures, such as personal protective equipment

##### Eye/face protection

Wear safety glasses with side shields (or goggles). Wear face shield if there is risk of splashes.

##### Skin protection

##### Hand protection

Wear chemical-resistant, impervious gloves. Use protective gloves made of: Rubber or plastic. Suitable gloves can be recommended by the glove supplier.

##### Other

Wear appropriate chemical resistant clothing. Rubber or plastic apron.

##### Respiratory protection

In case of inadequate ventilation or risk of inhalation of dust, use suitable respiratory equipment with particle filter. In the United States of America, if respirators are used, a program should be instituted to assure compliance with OSHA 29 CFR 1910.134.

Measurement Element: Manganese (Mn)

10 mg/m<sup>3</sup>

Any particulate respirator equipped with an N95, R95, or P95 filter (including N95, R95, and P95 filtering facepieces) except quarter-mask respirators. The following filters may also be used: N99, R99, P99, N100, R100 or P100.

Any supplied-air respirator.

25 mg/m<sup>3</sup>

Any supplied-air respirator operated in a continuous-flow mode.

Any powered, air-purifying respirator with a high-efficiency particulate filter.

50 mg/m<sup>3</sup>

Any air-purifying, full-face piece respirator equipped with an N100, R100, or P100 filter.

Any supplied-air respirator with a tight-fitting face piece that is operated in a continuous-flow mode.

Any powered, air-purifying respirator with a tight-fitting face piece and a high-efficiency particulate filter.

Any self-contained breathing apparatus with a full face piece.

Any supplied-air respirator with a full face piece.

## Appendix B: Safety Data Sheet

---

|                                       |   |
|---------------------------------------|---|
|                                       | 500 mg/m <sup>3</sup><br>Any supplied-air respirator operated in a pressure-demand or other positive-pressure mode.<br>Emergency or planned entry into unknown concentrations or IDLH conditions -<br>Any self-contained breathing apparatus that has a full face piece and is operated in a pressure-demand or other positive-pressure mode. |
|                                       | Escape<br>Any air-purifying, full-face piece respirator equipped with an N100, R100, or P100 filter.<br>Any appropriate escape-type, self-contained breathing apparatus.  |
| <b>Thermal hazards</b>                | Wear appropriate thermal protective clothing, when necessary.   |
| <b>General hygiene considerations</b> | When using, do not eat, drink or smoke. Keep from contact with clothing and other combustible materials. Remove and wash contaminated clothing promptly. Wash hands before breaks and immediately after handling the product. Handle in accordance with good industrial hygiene and safety practice.  |

### 9. Physical and chemical properties

|   |   |
|---|---|
| <b>Appearance</b>                                   | Dark purple solid with metallic luster.   |
| <b>Physical state</b>                               | Solid.  |
| <b>Form</b>   | Solid   |
| <b>Color</b>  | Dark purple.  |
| <b>Odor</b>   | Odorless.   |
| <b>Odor threshold</b>                               | Not available.  |
| <b>pH</b>   | Not applicable.   |
| <b>Melting point/freezing point</b>                 | Starts to decompose with evolution of oxygen (O <sub>2</sub> ) at temperatures above 150 °C. Once initiated, the decomposition is exothermic and self-sustaining. |
| <b>Initial boiling point and boiling range</b>      | Not applicable.   |
| <b>Flash point</b>                                  | Not applicable.   |
| <b>Evaporation rate</b>                             | Not applicable.   |
| <b>Flammability (solid, gas)</b>                    | Not applicable.   |
| <b>Upper/lower flammability or explosive limits</b> |   |
| <b>Flammability limit - lower (%)</b>               | Not applicable.   |
| <b>Flammability limit - upper (%)</b>               | Not applicable.   |
| <b>Explosive limit - lower (%)</b>                  | Not available.  |
| <b>Explosive limit - upper (%)</b>                  | Not available.  |
| <b>Vapor pressure</b>                               | < 0 kPa at 25 °C  |
| <b>Vapor density</b>                                | Not applicable  |
| <b>Relative density</b>                             | 2.7 (20 °C) ( Water = 1)  |
| <b>Solubility(ies)</b>                              |   |
| <b>Solubility (water)</b>                           | 6 % (20 °C)   |
| <b>Partition coefficient (n-octanol/water)</b>      | Not available.  |
| <b>Auto-ignition temperature</b>                    | Not available.  |
| <b>Decomposition temperature</b>                    | 464 °F (240 °C)   |
| <b>Viscosity</b>                                    | Not applicable.   |
| <b>Other information</b>                            |   |
| <b>Density</b>                                      | 2.70 g/cm <sup>3</sup>  |
| <b>Explosive properties</b>                         | Not explosive. Can explode in contact with sulfuric acid, peroxides and metal powders.  |
| <b>Molecular formula</b>                            | H-Mn-O <sub>4</sub> .K  |
| <b>Molecular weight</b>                             | 158.03 g/mol<br>158.03  |
| <b>Oxidizing properties</b>                         | Strong oxidizing agent.   |

## Appendix B: Safety Data Sheet

---

### 10. Stability and reactivity

|   |   |
|---|---|
| <b>Reactivity</b>                         | The product is stable and non-reactive under normal conditions of use, storage and transport.   |
| <b>Chemical stability</b>                 | Stable at normal conditions.  |
| <b>Possibility of hazardous reactions</b> | Contact with combustible material may cause fire. Can explode in contact with sulfuric acid, peroxides and metal powders. Starts to decompose with evolution of oxygen (O <sub>2</sub> ) at temperatures above 150 °C. Once initiated, the decomposition is exothermic and self-sustaining. |
| <b>Conditions to avoid</b>                | Contact with incompatible materials or heat (135 °C / 275 °F) could result in violent exothermic chemical reaction.   |
| <b>Incompatible materials</b>             | Acids. Peroxides. Reducing agents. Combustible material. Metal powders. Contact with hydrochloric acid liberates chlorine gas.  |
| <b>Hazardous decomposition products</b>   | By heating and fire, corrosive vapors/gases may be formed.  |

### 11. Toxicological information

#### Information on likely routes of exposure

|   |  |
|---|--|
| <b>Ingestion</b>  | Harmful if swallowed.  |
| <b>Inhalation</b>   | May cause irritation to the respiratory system.  |
| <b>Skin contact</b>   | Causes severe skin burns.  |
| <b>Eye contact</b>  | Causes serious eye damage.   |
| <b>Symptoms related to the physical, chemical and toxicological characteristics</b> | Contact with this material will cause burns to the skin, eyes and mucous membranes. Permanent eye damage including blindness could result. |

#### Information on toxicological effects

**Acute toxicity** Harmful if swallowed.

| <b>Components</b> | <b>Species</b> | <b>Test Results</b> |
|-------------------|----------------|---------------------|
|-------------------|----------------|---------------------|

---

Potassium permanganate (CAS 7722-64-7)

| <b>Components</b>   | <b>Species</b>  | <b>Test Results</b> |
|---|---|---------------------|
| <b>Acute</b>  |   |                     |
| <i>Dermal</i>   |   |                     |
| LD50  | Rat   | 2000 mg/kg          |
| <i>Oral</i>   |   |                     |
| LD50  | Rat   | 2000 mg/kg          |
| <b>Skin corrosion/irritation</b>                          | Causes severe skin burns.   |                     |
| <b>Serious eye damage/eye irritation</b>                  | Causes serious eye damage.  |                     |
| <b>Respiratory or skin sensitization</b>                  |   |                     |
| <b>Respiratory sensitization</b>                          | Not classified.   |                     |
| <b>Skin sensitization</b>                                 | Not classified.   |                     |
| <b>Germ cell mutagenicity</b>                             | Not classified.   |                     |
| <b>Carcinogenicity</b>                                    | Not classified.   |                     |
| <b>Reproductive toxicity</b>                              | Not classified.   |                     |
| <b>Specific target organ toxicity - single exposure</b>   | Causes damage to organs (respiratory system).   |                     |
| <b>Specific target organ toxicity - repeated exposure</b> | Causes damage to organs (respiratory system, central nervous system) through prolonged or repeated exposure.  |                     |
| <b>Aspiration hazard</b>                                  | Not classified.   |                     |
| <b>Chronic effects</b>                                    | May cause damage to respiratory system. Prolonged exposure, usually over many years, to manganese oxide fume/dust can lead to chronic manganese poisoning, chiefly affecting the central nervous system |                     |

## Appendix B: Safety Data Sheet

### 12. Ecological information

**Ecotoxicity** Very toxic to aquatic life with long lasting effects.

| Components                             | Species   | Test Results   |
|--|---|--|
| Potassium permanganate (CAS 7722-64-7) |   |  |
| Aquatic                                |   |  |
| Fish                                   | LC50  |  |
|  | Bluegill ( <i>Lepomis macrochirus</i> )                       | 2.7 mg/l, 96 hours, static<br>2.3 mg/l, 96 hours, flow through<br>2.3 mg/l, 96 hours<br>1.8 - 5.6 mg/l |
|  | Carp ( <i>Cyprinus carpio</i> )                               | 3.16 - 3.77 mg/l, 96 hours<br>2.97 - 3.11 mg/l, 96 hours   |
|  | Goldfish ( <i>Carassius auratus</i> )                         | 3.3 - 3.93 mg/l, 96 hours, static  |
|  | Milkfish, salmon-herring ( <i>Chanos chanos</i> )             | > 1.4 mg/l, 96 hours   |
|  | Rainbow trout ( <i>Oncorhynchus mykiss</i> )                  | 1.8 mg/l, 96 hours<br>1.08 - 1.38 mg/l, 96 hours<br>0.77 - 1.27 mg/l, 96 hours                         |
|  | Rainbow trout, donaldson trout ( <i>Oncorhynchus mykiss</i> ) | 0.275 - 0.339 mg/l, 96 hours   |

**Persistence and degradability** Expected to be readily converted by oxidizable materials to insoluble manganese oxide.

**Bioaccumulative potential** Potential to bioaccumulate is low.

**Mobility in soil** The product is miscible with water. May spread in water systems.

**Other adverse effects** None known.

### 13. Disposal considerations

**Disposal instructions** Dispose of contents/container in accordance with local/regional/national/international regulations.

**Hazardous waste code** D001: Ignitable waste  
The Waste code should be assigned in discussion between the user, the producer and the waste disposal company.

**Waste from residues / unused products** Do not allow this material to drain into sewers/water supplies.

**Contaminated packaging** Since emptied containers may retain product residue, follow label warnings even after container is emptied. Rinse container at least three times to an absence of pink color before disposing. Empty containers should be taken to an approved waste handling site for recycling or disposal.

### 14. Transport Information

#### DOT

|                                     |   |
|-------------------------------------|---|
| <b>UN number</b>                    | UN1490  |
| <b>UN proper shipping name</b>      | Potassium permanganate  |
| <b>Transport hazard class(es)</b>   |   |
| <b>Class</b>                        | 5.1   |
| <b>Subsidiary risk</b>              | -   |
| <b>Packing Group</b>                | II  |
| <b>Environmental hazards</b>        |   |
| <b>Marine pollutant</b>             | Yes   |
| <b>Special precautions for user</b> | Read safety instructions, SDS and emergency procedures before handling. |
| <b>Special provisions</b>           | IB8, IP2, IP4, T3, TP33   |
| <b>Packaging exceptions</b>         | 152   |
| <b>Packaging non bulk</b>           | 212   |
| <b>Packaging bulk</b>               | 240   |

## Appendix B: Safety Data Sheet

---

### IATA

|                              |   |
|------------------------------|---|
| UN number                    | UN1490  |
| UN proper shipping name      | Potassium permanganate  |
| Transport hazard class(es)   |   |
| Class                        | 5.1   |
| Subsidiary risk              | -   |
| Label(s)                     | 5.1   |
| Packing Group                | II  |
| Environmental hazards        | Yes   |
| ERF Code                     | 5L  |
| Special precautions for user | Read safety instructions, SDS and emergency procedures before handling. |

### IMDG

|                              |   |
|------------------------------|---|
| UN number                    | UN1490  |
| UN proper shipping name      | POTASSIUM PERMANGANATE  |
| Transport hazard class(es)   |   |
| Class                        | 5.1   |
| Subsidiary risk              | -   |
| Label(s)                     | 5.1   |
| Packing Group                | II  |
| Environmental hazards        |   |
| Marine pollutant             | Yes   |
| EmS                          | F-H, S-Q  |
| Special precautions for user | Read safety instructions, SDS and emergency procedures before handling. |

Transport in bulk according to Annex II of MARPOL 73/78 and the IBC Code Not applicable.

## 15. Regulatory Information

**US federal regulations** This product is a "Hazardous Chemical" as defined by the OSHA Hazard Communication Standard, 29 CFR 1910.1200.  
All components are on the U.S. EPA TSCA Inventory List.  
  
Drug Enforcement Administration (DEA) (21 CFR 1310.02 (b) 8: List II chemical.  
  
Department of Homeland Security (DHS) Chemical Facility Anti-Terrorism Standards (6 CFR 27, Appendix A): Listed.

### TSCA Section 12(b) Export Notification (40 CFR 707, Subpt. D)

Not regulated

### US. OSHA Specifically Regulated Substances (29 CFR 1910.1001-1050)

Not listed

### CERCLA Hazardous Substance List (40 CFR 302.4)

Potassium permanganate (CAS 7722-64-7) LISTED

### Superfund Amendments and Reauthorization Act of 1986 (SARA)

**Hazard categories** Immediate Hazard - Yes  
Delayed Hazard - Yes  
Fire Hazard - Yes  
Pressure Hazard - No  
Reactivity Hazard - No

### SARA 302 Extremely hazardous substance

Not listed.

### SARA 302 Extremely hazardous substance

Not listed.

## Appendix B: Safety Data Sheet

### SARA 311/312 Hazardous chemical

Yes

### SARA 313 (TRI reporting)

| Chemical name          | CAS number | % by wt. |
|------------------------|------------|----------|
| Potassium permanganate | 7722-64-7  | > 97.5   |

### Other federal regulations

#### Clean Air Act (CAA) Section 112 Hazardous Air Pollutants (HAPs) List

Potassium permanganate (CAS 7722-64-7)

#### Clean Air Act (CAA) Section 112(r) Accidental Release Prevention (40 CFR 68.130)

Not regulated.

#### Clean Water Act (CWA) Section 112(r) (40 CFR 68.130)

Hazardous substance

#### Safe Drinking Water Act (SDWA)

Not regulated.

#### Drug Enforcement Administration (DEA). List 2, Essential Chemicals (21 CFR 1310.02(b) and 1310.04(f)(2) and Chemical Code Number

Potassium permanganate (CAS 7722-64-7) 6579

#### Drug Enforcement Administration (DEA). List 1 & 2 Exempt Chemical Mixtures (21 CFR 1310.12(c))

Potassium permanganate (CAS 7722-64-7) 15 % wt

#### DEA Exempt Chemical Mixtures Code Number

Potassium permanganate (CAS 7722-64-7) 6579

### US state regulations

#### US. Massachusetts RTK - Substance List

Potassium permanganate (CAS 7722-64-7)

#### US. New Jersey Worker and Community Right-to-Know Act

Potassium permanganate (CAS 7722-64-7)

#### US. Pennsylvania Worker and Community Right-to-Know Law

Potassium permanganate (CAS 7722-64-7)

#### US. Rhode Island RTK

Potassium permanganate (CAS 7722-64-7)

#### US - California Proposition 65 - Carcinogens & Reproductive Toxicity (CRT): Listed substance

Not listed.

#### US - California OSH Hazardous Substance List

Listed.

This product does not contain a chemical known to the State of California to cause cancer, birth defects or other reproductive harm.

### International Inventories

| Country(s) or region        | Inventory name   | On inventory (yes/no)* |
|-----------------------------|--|------------------------|
| Australia                   | Australian Inventory of Chemical Substances (AICS)                     | Yes                    |
| Canada                      | Domestic Substances List (DSL)   | Yes                    |
| Canada                      | Non-Domestic Substances List (NDSL)                                    | No                     |
| China                       | Inventory of Existing Chemical Substances in China (IECSC)             | Yes                    |
| Europe                      | European Inventory of Existing Commercial Chemical Substances (EINECS) | Yes                    |
| Europe                      | European List of Notified Chemical Substances (ELINCS)                 | No                     |
| Japan                       | Inventory of Existing and New Chemical Substances (ENCS)               | Yes                    |
| Korea                       | Existing Chemicals List (ECL)  | Yes                    |
| New Zealand                 | New Zealand Inventory  | Yes                    |
| Philippines                 | Philippine Inventory of Chemicals and Chemical Substances (PICCS)      | Yes                    |
| United States & Puerto Rico | Toxic Substances Control Act (TSCA) Inventory                          | Yes                    |

## Appendix B: Safety Data Sheet

---

\* "Yes" indicates this product complies with the inventory requirements administered by the governing country(s).  
"No" indicates that one or more components of the product are not listed or exempt from listing on the inventory administered by the governing country(s).

### 16. Other information, including date of preparation or last revision

**Issue date** 27-November-2013  
**Revision date** 23-April-2014  
**Version #** 02  
**Further information** HMIS® is a registered trade and service mark of the NPCA.  
**NFPA Ratings**



**List of abbreviations** GHS: Globally Harmonized System of Classification and Labeling of hazardous properties of Chemicals.  
TWA: Time weighted average.  
LD50: Lethal Dose, 50%.  
LC50: Lethal Concentration, 50%.  
IMDG: International Maritime Dangerous Goods.  
IATA: International Air Transport Association.  
MARPOL: International Convention for the Prevention of Pollution from Ships.

**References** HSDB® - Hazardous Substances Data Bank  
Registry of Toxic Effects of Chemical Substances (RTECS)  
IARC Monographs. Overall Evaluation of Carcinogenicity  
National Toxicology Program (NTP) Report on Carcinogens  
ACGIH Documentation of the Threshold Limit Values and Biological Exposure Indices

**Disclaimer** The information contained herein is accurate to the best of our knowledge. However, data, safety standards and government regulations are subject to change and, therefore, holders and users should satisfy themselves that they are aware of all current data and regulations relevant to their particular use of product. CARUS CORPORATION DISCLAIMS ALL LIABILITY FOR RELIANCE ON THE COMPLETENESS OR ACCURACY OR THE INFORMATION INCLUDED HEREIN. CARUS CORPORATION MAKES NO WARRANTY, EITHER EXPRESS OR IMPLIED, INCLUDING, BUT NOT LIMITED TO, ANY WARRANTIES OF MERCHANTABILITY OR FITNESS FOR PARTICULAR USE OR PURPOSE OF THE PRODUCT DESCRIBED HEREIN. All conditions relating to storage, handling, and use of the product are beyond the control of Carus Corporation, and shall be the sole responsibility of the holder or user of the product.

CAIROX® is a registered trademark of Carus Corporation. Copyright 1998

**This SDS contains revisions in the following section(s):** This safety data sheet contains revisions in the following section(s):